

HF SSB USER'S GUIDE



& PROFESSIONAL PRODUCTS CATALOG



SGC



"No Compromise Communications"



HF-SSB COMMUNICATIONS: THE POWER TO LOCK IN THE WORLD.

Globally, HF-SSB has literally changed the world. For a minimal investment, it has allowed millions of people - often in amazingly remote settings, often in emergency conditions - to reliably bounce clear voice and data signals across a state, across a continent, over an ocean, or around the world. Without satellites, relay stations, cellular nets, stadium sized antennas or huge user fees. Just some fine equipment, a smart operator and nature's own ionosphere make this possible.

For nearly 25 years, the perfection of HF SSB has been the focus and the life of our company. Our efforts have not gone unnoticed. Today, SGC is a prominent choice of leading corporations, governments, relief agencies, paramilitary



organizations, mariners, aviators, explorers, and scientists - all over the world. They trust our engineering and they value our experience.

A vital part of our company's strategy centers around new product development, with an emphasis on providing quality equipment which remains rugged, reliable and competitively priced. We are focused on providing customer service of the highest standard. Our commitment is to product training and comprehensive after sales

support. Today, SGC is recognized as a world class designer and manufacturer of HF SSB communications products.

At SGC we build communications power tools. Next generation HF-SSB radios, antennas, amplifiers and coupler systems that squeeze more range and clarity out of every watt of HF SSB communications power, are the technology and innovations that have helped SGC emerge as a cutting edge player in the expanding world of HF-SSB.

Actually, SGC was the first company to perfect and mass produce solid-state HF SSB radios, more than 20 years ago. Today, our focus is an ever higher level of HF SSB refinement and performance. All focused on creating HF SSB voice and data communications systems that are so user friendly and so powerful, they allow every SGC user to easily lock in the world. SGC - HF SSB Power Tools!

Pierre B. Goral, President

CONTENTS

CHAPTER 1 **USERS OF LONG-RANGE RADIO EQUIPMENT** **HF SSB HIGH FREQUENCY SINGLE SIDEBAND.....7**

WHAT IS SSB?.....	8
SSB'S HIGH EFFICIENCY	9
HF SIGNAL CHARACTERISTICS	10
PROPAGATION	12
NATURAL CYCLES THAT AFFECT PROPAGATION	12
HF INTERFERENCE.....	14
SIGNAL PATHS	15
OPERATING NECESSITIES	16
INFORMATION SOURCES.....	17
OPERATING MODES	19
MORSE CODE.....	19
CW (CONTINUOUS WAVE)	19
VOICE	19
AM (AMPLITUDE MODULATION)	19
SSB (SINGLE SIDEBAND)	20
DATA	20
VIDEO	21
HF SSB vs. VHF/UHF RADIO COMMUNICATION SYSTEMS	22
VHF/UHF COMMUNICATIONS	22
COVERAGE.....	23
REPEATERS REQUIRED ON VHF/UHF	24
NO REPEATERS WITH HF SSB.....	25
SECURITY	25
POWER.....	26
INSTALLATION	26
COST	27

CHAPTER 2 **HF TRANSCEIVER SPECIFICATIONS AND FEATURES.....29**

HF TRANSCEIVER SPECIFICATIONS AND FEATURES	30
MODES.....	30
TRANSMITTER/RECEIVER BANDS AND FREQUENCY RANGE.....	30
POWER OUTPUT.....	30
FREQUENCY STABILITY AND CRYSTAL OVEN.....	31

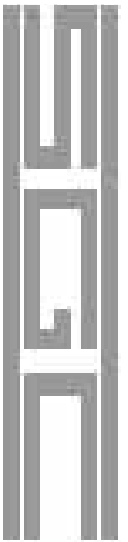

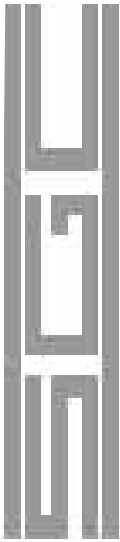

FREQUENCY STEP	31
SENSITIVITY	31
SELECTIVITY	32
OPERATING TEMPERATURE RANGE	32
POWER REQUIREMENTS	32
CURRENT DRAW	32
DUTY CYCLE	33
DISPLAY AND ILLUMINATION	33
METERING	33
MEMORIES	34
SCAN	34
ALARM	34
AUTO ALARM	34
BREAK-IN KEYING (QSK)	34
SIDETONE	35
FILTERS	35
DSP (DIGITAL SIGNAL PROCESSING)	35
DSP IN HF COMMUNICATIONS	36
DSP TECHNOLOGY	36
SPEAKER/HEADPHONE/RECORD OUTPUTS	37
AUDIO I/O/ PORTS	38
AGC (AUTOMATIC GAIN CONTROL)	38
NOISE BLANKER	38
FREQUENCY OFFSETS	38
PTT (PUSH-TO-TALK TRANSMITTER)	38
VOX (VOICE ACTIVATED TRANSMITTER)	39
SPEECH PROCESSING	39
ATTENUATOR	39
SIMPLEX/DUPLEX OPERATION	39
SQUELCH	39
SPLIT-FREQUENCY OPERATION	40
SELECTABLE SIDEBANDS	40
DATA TRANSMISSION	40
COMPUTER CONTROL	40
REMOTE CONTROL	41
ALE (AUTOMATIC LINK ESTABLISHMENT)	41
ENCRYPTIONS AND SCRAMBLING	41
GENERAL-COVERAGE RECEIVE	41
CHANNEL OPERATION	42
POWER SUPPLIES	42
CABLING	42
AC (MAINS) POWER SUPPLIES	44
TRANSFORMER-RECTIFIER POWER SUPPLIES	44
MOBILE POWER SUPPLIES	45

SOLAR-POWERED CHARGERS	46
HUMAN POWERED CHARGERS.....	46

CHAPTER 3
HF ANTENNAS, FEEDLINES AND GROUNDS 47

HF ANTENNAS, FEEDLINES & GROUNDS	48
OPERATING ENVIRONMENT.....	48
BASE	48
MOBILE	48
MARINE.....	49
FIELD	49
AERONAUTICAL	50
ANTENNA PATTERN BASICS	50
ANTENNA CONSTRUCTION BASICS	53
ANTENNA TYPES	54
LONGWIRES AND RANDOM-LENGTH WIRES.....	54
VEES AND RHOMBICS.....	55
THE QUARTER WAVE VERTICAL	56
THE VERTICAL WHIP.....	57
THE WINDOM ANTENNA	57
THE DIPOLE AND ITS VARIATIONS.....	57
BEAM AND YAGI ANTENNAS.....	58
LOG-PERIODIC ANTENNA	58
LOOP ANTENNA.....	59
BOXES AND DELTAS	59
QUADS.....	60
MOBILE ANTENNA VARIATIONS	60
FEEDLINES	61
GROUNDING SYSTEMS	64
EQUIPMENT GROUNDS	64
RF COUNTERPOISES AND GROUND PLANES.....	64
BASE STATION GROUNDS.....	65
FIELD-OPERATION GROUNDS.....	66
MOBILE GROUNDS	67
SAILBOAT AND POWERBOAT GROUNDS.....	68
AIRCRAFT GROUNDS	70
GROUND DAMAGE, AGEING AND MAINTENANCE.....	70

CHAPTER 4
INSTALLATION 71

INSTALLATION	72
TRANSCEIVER	72
RUNNING POWER CABLES.....	73
CONNECTING AND CONNECTOR TYPES	74



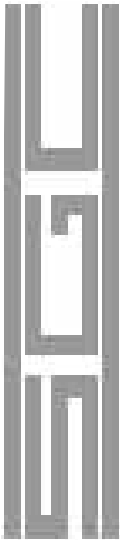

CONNECTING THE GROUND.....	74
CONNECTING THE FEEDLINE.....	74
CONNECTING THE AUDIO I/O JACK ASSEMBLY	74
CONNECTING THE REMOTE CONTROL	75
COUPLER	76
LOCATION	76
CONNECTION TO POWER	76
CONNECTION TO RF GROUND	77
CONNECTION TO TRANSCEIVER.....	78
CONNECTION TO ANTENNA	78
THE COUPLER IN A HARSH ENVIRONMENT.....	79
ANTENNA	79
LOCATION	80
FEEDLINES	81
FEEDTHROUGH CONNECTORS OR HOLES	81
FEEDLINE ROUTING	81
HARSH ENVIRONMENTS	82
NOISE AND INTERFERENCE.....	82
NATURAL INTERFERENCE.....	82
MAN-MADE INTERFERENCE.....	83
NOISE REMEDIES AT THE TRANSCEIVER	84
DIGITAL SIGNAL PROCESSING (DSP)	84
NOISE BLANKER.....	84
MAGNETIC ANTENNAS	84
CHANGE OF FREQUENCY.....	85
NOISE REMEDIES AT THE NOISE SOURCE	85
ISOLATION AND BY-PASSING	85
BONDING	86
STATIC COLLECTORS.....	86
SHIELDING	87
GROUNDING	87
MOVING THE ANTENNA	87
POWER CONCEPTS	88
FORWARD POWER.....	88
REFLECTED POWER	89
STANDING WAVES	89
VSWR.....	89
FIELD STRENGTH	89
FREQUENCY.....	90
GAINS AND LEVELS.....	90
DO-IT-YOURSELF LIGHT-BULB DUMMY LOAD.....	90
RADIO TEST PROCEDURE.....	92
COUPLER TEST PROCEDURE.....	93
INSTRUMENTS.....	93
WATTMETER	93
SWR METER	93
FIELD STRENGTH METER.....	94

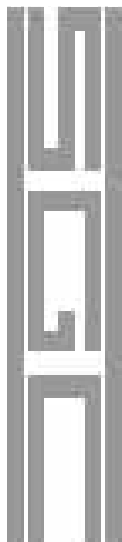

FREQUENCY COUNTER.....	94
IMPEDANCE BRIDGE	94
S-METER	94

CHAPTER 5
AMATEUR RADIO 95

AMATEUR RADIO	96
AMATEUR OPERATIONS	97
COMMERCIAL LICENSING	98
STATION LICENSES.....	99
OPERATOR LICENSES.....	99

CHAPTER 6
MARINE OPERATIONS 101

MARINE OPERATIONS.....	102
SHIP-TO-SHORE CALLS	102
TELEPHONE CALLS.....	103
SHIP-TO-SHIP CALLS.....	105
EMERGENCY CALLS.....	105

CHAPTER 7
SGC'S VISION OF SMART PRODUCTS 107

THE HISTORY OF SGC.....	108
SGC PRODUCT LINE	109
THE SGC VISION OF HF	109
MARKETING PLANS	110
THE EXPORT PICTURE.....	111
THE SG-2000 HF TRANSCEIVER.....	112
THE SG-2000: A NEW STYLE OF OPERATION	115
SGC SG-2000 POWERTALK™	116
ADSP™ NOISE REDUCTION	117
SNST™ NOISE REDUCTION	118
FIRST MOBILE DSP TRANSCEIVER	118
VISUAL DSP FILTER DISPLAY	118
PROGRAMMABLE DIGITAL FILTERS.....	118
PRE-PROGRAMMED FILTER SETTINGS.....	119
NOTCH FILTER	119
VARIABLE BANDPASS, LOW-PASS, AND HIGH-PASS FILTERS	119
UPGRADE DSP HEAD	119
REMOVABLE HEAD.....	119
SIMPLE DESIGN OF FRONT-PANEL CONTROLS	120
BIG-POWER/SMALL PACKAGE.....	120
TESTED FOR HIGH QUALITY	120
SG-2000 FEATURES AND BENEFITS.....	121

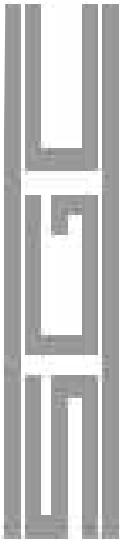

QMS™ (QUICK MOUNT SYSTEM).....	123
QMS FEATURES AND BENEFITS	127
SG-230 SMARTUNER™	128
SG-230 FEATURES AND BENEFITS.....	131
SG-303, SG-103 AND SG-104 ANTENNA SYSTEMS	133
SG-303 FEATURES AND BENEFITS	134
SG-500 SMART POWERCUBE™.....	135
SG-500 SMART POWERCUBE™ BENEFITS & FEATURES.....	136
THE OTHER SGC PRODUCTS.....	136
PRC-2250 MIL	137
SG-715 MANPACK	137
SG-1000-1 LINEAR AMPLIFIER.....	138
FEATURES/BENEFITS OF SG-2000.....	139
QMS FEATURES AND BENEFITS	140
SG-230 FEATURES & BENEFITS	141
SG-303 FEATURES & BENEFITS	142

CHAPTER 8

GLOSSARY & GENERAL ELECTRONIC AND HF SSB ABBREVIATIONS .143

SGC IDEAS AND OPPORTUNITIES).....	148
WARRANTY	149
SGC QUOTATION REQUEST FORM.....	150

CHAPTER 1

**USERS OF LONG-RANGE
RADIO EQUIPMENT**

**HF-SSB
HIGH FREQUENCY
SINGLE SIDEBAND**

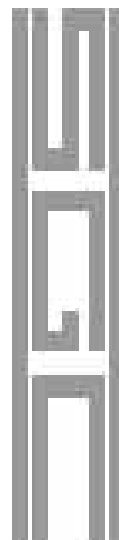



USERS OF LONG-RANGE RADIO EQUIPMENT

MARINE & FISHING Marine and fishing vessels require HF communications. Transmissions in the HF range can often reach thousands of miles, and when a ship is far from shore, no other communications system would be as effective and inexpensive.

AVIATION Although aircraft are often flying in areas where line-of-sight communications (such as UHF and VHF frequencies) are useful, HF equipment is necessary for any long-distance transmissions.

COMMERCIAL Commercial users of the HF spectrum typically use this equipment to contact personnel in distant or remote areas, where any other medium would be either impossible or too expensive.

MILITARY Various branches of the military have traditionally used the HF bands for base and field communications.

GOVERNMENT Because not all government communications cover short distances, HF frequencies are used exclusively in sensitive long distance communications and in remote regions which are difficult to reach, such as deserts, dense forests and mountainous regions. And, for embassy transmissions, HF is a must.

LAW ENFORCEMENT Like other government communications, law enforcement can be served with UHF and VHF equipment. However, for long-distance operations, the national branches of U.S. law enforcement, such as the FBI, use HF frequencies.

AMATEUR RADIO Amateur operators (sometimes known as "hams") are licensed hobbyists who communicate via two-way radio on a number of frequency bands. As a result of the frequencies and the powers that they use, amateurs are commonly heard around the world.

WHAT IS SSB?

Before you can understand what SSB is, you must understand how audio is transmitted via radio waves. The method by which audio is impressed on a radio signal is called modulation. The two types of modulation that most people are familiar with are AM (amplitude modulation) and FM (frequency modulation). The AM and FM broadcast bands were so named as a result of these two types of modulation. In an AM-modulated radio signal, a base signal, called the carrier, is continuously broadcast. The two modulating signals are called the sidebands. Any audio that you hear on an AM broadcast station is from the two sidebands. When the radio station is not transmitting any sound, you can still hear that a signal is present; that is the carrier.

These two modulating (audio) sidebands are located on either side of the carrier signal--one just above, the

other just below. As a result, the sideband located just above the carrier frequency is called the upper sideband and that which is located just below the carrier frequency is called the lower sideband.

The pieces that fit together to form an AM broadcast signal are quite important. Although AM signals were transmitted almost exclusively for decades, it was discovered that the AM signal could be dissected. The first amateur radio operators to experiment with these processes often used both sidebands without the carrier.



This is known as double sideband

(DSB). DSB was typically used in the earlier operations because it was much easier to strip out just the carrier than to strip out the carrier and one of the sidebands. Several years later (and still true today), it was much more common in the amateur bands to merely transmit using one of the sidebands, which is known as single sideband (SSB). Single sideband transmissions can either consist of just the lower sideband (LSB) or the upper sideband (USB).

If you listen to an SSB signal on an AM modulation receiver, the voices are altered and sound a lot like cartoon ducks. As a result, you must have a special SSB receiver to listen to these transmissions. Although this was often difficult for the amateur radio operators of the 1950's, it is no longer a problem with today's modern SSB transceivers, such as the SG-2000.

You might wonder why SSB modulation is used for some applications and AM is used for broadcasting. It is a necessity for broadcasters to have excellent fidelity when transmitting music; otherwise, the typical radio listener will tune to another station. In order to achieve excellent fidelity when transmitting music, both sidebands and the carrier are necessary. To produce this AM signal, the transmitter is, in effect, working as three transmitters: one to produce a strong carrier for each of the sidebands, an upper sideband, and a lower sideband. The result is that approximately half of the transmitter power is "wasted" on a blank carrier and the rest of the power is divided between the two sidebands. As a result, the actual audio output from a 600-watt AM transmitter (300 watts of carrier + 150 watts on each sideband) would be the same as the SG-2000 150-watt SSB transmitter.

SSB'S HIGH EFFICIENCY

Let's run some numbers: Suppose you have a typical 5-kW broadcast transmitter. You will only be able to impress 2.5 kW of audio power on that signal. This means that each of the two sidebands will have only 1.25 kW of power.

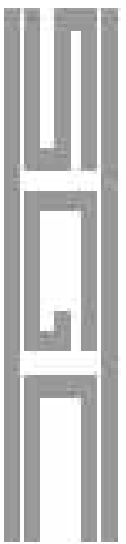

SSB Power! The actual audio output of a 150-watt SSB transmitter is the same as a 600-watt AM transmitter.

This is the key to highly effective communications using single sideband. A single sideband signal removes the carrier and one sideband and concentrates all of its energy in one sideband. Thus, a 1-kW SSB signal will "talk" as far as a 4-kW conventional AM or FM transmitter. It is why long distances can be covered effectively with SSB.

A single-sideband signal removes the carrier and one sideband and concentrates all of its energy in the remaining sideband.

Single sideband's benefit is not only evident on transmission. The reverse happens on receive. When you work out the math, the efficiency with an SSB signal is 16 times greater than with a conventional AM signal.

HF SIGNAL CHARACTERISTICS

HF (high frequency) is synonymous with the more familiar term, shortwave. The only difference is that HF is typically used when discussing two-way and point-to-point communications. Shortwave is typically used when referring to broadcast stations in the same range. In amateur radio, both terms are frequently used.

The HF band extends from 1700 to 30,000 kHz (1.7 to 30 MHz). To give some perspective to these numbers,

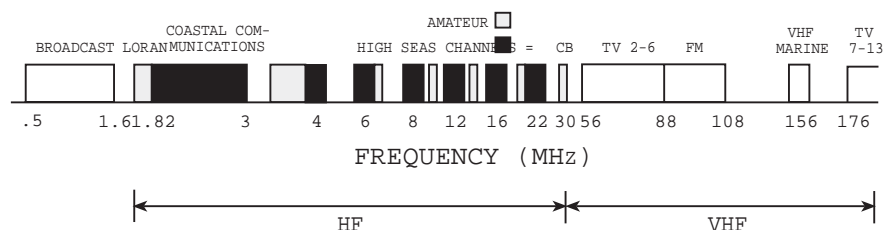

the AM broadcast band runs from 540 to 1700 kHz, the Citizen's Band (CB) runs from 26,960 to 27,230 kHz (within the HF band), and television channel 2 is on 54,000 kHz. Each of these sample frequencies has different characteristics, and it is vitally important to learn this information so that you can effectively use the HF spectrum.

The HF high frequency band extends from 1700 to 30,000 kHz (1.7 to 30 MHz).

When talking about HF, most people list the frequencies in either kHz (kilohertz) or MHz (megahertz). This is a matter of convenience only. The base rate for frequency is the hertz (Hz), named after Heinrich Hertz, an important "father of radio." One kHz equals 1000 Hz and one MHz equals 1,000 kHz.

The Hz divisions of the radio spectrum aren't arbitrarily chosen hashmarks to divide your radio dial into usable little pieces. Instead, the divisions relate directly to the frequency. Signals such as light, radio, and sound are all waves. These waves travel through the air in a manner that is somewhat similar to waves in a pond. Each radio wave has a peak and a valley. The length of each radio wave is (not surprisingly) known as the wavelength. Radio waves

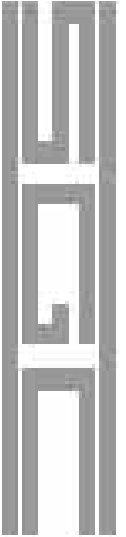

travel at the speed of light, so the longer each wave is, the fewer waves can arrive in one second. The number of waves that arrive per second determines the frequency. Although the wavelength and the frequency are different ways of saying the same thing, wavelengths for radio are rarely given. In the 1920's through the 1940's, the wavelength was more frequently used than the frequency, however. This was probably the case because the wavelength seemed like a more tangible measurement at the time. The wavelength of the radio signal is also important because it determines the length of the antenna that you will need for receiving and especially for transmitting. Antennas are covered later in this user guide.

Because of the signal characteristics on the AM and FM broadcast bands, combined with the less effective internal antennas, radio signals are often thought of as being used for primarily local reception (100 miles or so). However, with two-way communications in the HF band, you are not listening for entertainment to the strongest station that you can find. You are attempting to communicate with a particular station under what could be life-threatening circumstances.

In the 1910's and 1920's, it was thought by most radio enthusiasts that the "wavelengths above 180 meters" were useless. In effect, these people believed that the frequencies above the top of today's AM broadcast band were unusable. Little did they know that the opposite was true for communications over medium to long distances. The reason that these pioneers were misled was because they didn't yet understand the methods by which radio waves travel.

These methods are known as propagation, but they can be simplified to provide a basic understanding of the subject. When you listen to a local AM broadcast station, you are receiving the ground wave signal. The ground wave travels along the ground for often a hundred miles or so from the transmitter location. The low frequencies, such as those in the AM broadcast band and lower, produce very large ground-wave patterns. The ground waves are very important because they produce solid, virtually fade-free reception.

The other major method by which radio signals reach your receiver are the sky waves . Sky waves travel toward the sky, rather than hang out on the ground. You would not be able to hear the sky-wave signals, except for the ionosphere. The ionosphere is many miles above the earth, where the air is "thin" containing few molecules. Here, the ionosphere is bombarded by x-rays, ultraviolet rays, and other forms of high-frequency radiation. The energy from the sun ionizes this layer by stripping electrons from the atoms.

"Skywaves" travel immense distances by multiple "bounces" off the ionosphere.

When a sky-wave signal reaches the ionosphere, it will either pass through it or the layer will refract the signal and bend it back to earth. The signal can be heard in the area where the signal reaches the earth, but depending on a number of variables, there might be an area where no signal from that particular transmitter is audible between the ground wave and where the sky wave landed. This area is the skip zone. After the sky-wave signal bounces on the earth, it will return toward the sky again. Again, the signal will be refracted by the ionosphere and return to the earth.

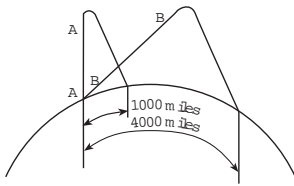

DURING THE DAY A 12 MHz SIGNAL (A) WOULD PROPAGATE OUT TO 1,000 MILES, WHILE AT THE SAME TIME, A 17 MHz SIGNAL (B) COULD REACH 4,000 MILES OR MORE BECAUSE OF THE INCREASED REFLECTION ANGLE.

If the HF signals all bent and bounced off the ionosphere with no losses in signal strength, HF stations around the world would be heard across the earth with perfect signals (something like a "super ball" was sent bouncing in a frictionless room). Whenever radio signals are refracted by the ionosphere or bounce from the earth, some of the energy is changed into heat. This is known as absorption. As a result, the signal at the first skip is stronger than the signal at the second skip, and so on. After several skips, typical HF signals will dissipate.

The skip and ground waves can be remarkably close together. It is not unusual for one station to receive a booming signal that nearly pegs the meter of a receiver. At the same time, a nearby station cannot hear a trace of the sending station even though using a better receiver with a better antenna. The first station was receiving either the ground wave or the first skip and the other station was located somewhere between these two.

PROPAGATION

If the HF users only had skip to contend with, the theories and uses of the HF spectrum would be simple. But several other factors also come into play. The critical angle of radiation is the steepest angle at which a radio signal can be refracted by the ionosphere. The critical angle depends on the frequency that is being used, the time of year, the time of day, etc. Sometimes a signal that shoots straight up from the antenna will be refracted by the ionosphere. In this case, the critical angle would be 0 degrees. In another case, the signal might slice through the ionosphere and continue into space. From this signal, you would not be able to determine the critical angle; you would only know that the sky-wave signal was above the critical angle.

The Critical Angle of Radiation is the steepest angle at which a radio signal can be refracted by the ionosphere.

NATURAL CYCLES THAT AFFECT PROPAGATION

Aside from the critical angle, the frequency used can also affect whether the signal will be passed through or refracted by the ionosphere. When a signal penetrates through the ionosphere without being refracted, the signal is said to operate above the Maximum Usable Frequency (MUF). The MUF is not a set frequency; it varies greatly, depending on the time of day and the part of the world that you are attempting to contact. Nearly the opposite of the MUF is the lowest usable frequency (LUF). However, the LUF has nothing to do with whether or not

The Maximum Usable Frequency (MUF) is lowest at night and highest during the day.

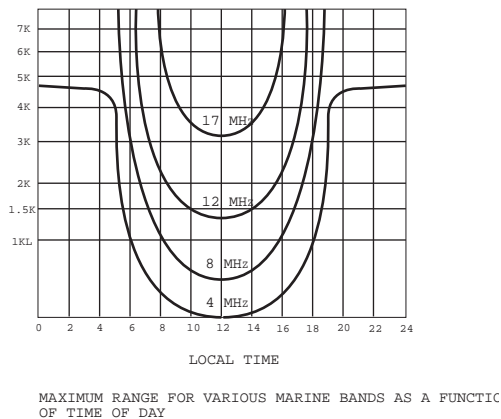

the signal will be refracted by the ionosphere; instead, it is the lowest frequency that you can use to reach a particular region (using a base standard amount of power).

In the daylight hours, the MUF is highest and in night hours, it is lower. There is also some seasonality, too. In the winter, with longer hours of darkness, the MUF is generally lower than the summer when the MUF is higher. Likewise, during the hours of darkness, when the ionosphere is less ionized, the LUF is lower, and during the daylight hours, it is much higher. The MUF and the LUF provide the boundaries between which you should operate the transceiver in order to make your contacts.

As mentioned in the previous paragraphs, propagation is affected by cyclical environmental conditions. The shortest of these conditions is the day/night cycle. In general, the transmitting and receiving conditions are by far the best in the nighttime hours. During the daytime, the MUF and LUF both rise and in order to talk across great distances, less reliable (because of the very long skip) higher frequencies must be used.

The next environmental cycle that affects propagation is the season of the year. The winter/summer cycles are somewhat like the day/night cycles, except to a lesser extent. In general, the MUF and LUF will both be higher in the summer and lower in the winter. Also, the noise from thunder storms and other natural phenomena are much higher during the summer. In fact, except for local transmissions, communications in the 1700 to 3000 kHz range during the summertime are of limited regular use.

The longest environmental cycle that affects propagation is the sunspot cycle. Before the age of radio, it was noticed that the number of solar storms (sun spots) varies from year to year. Also, the number of sunspots per year was not entirely random. The number of solar storms during a good propagational month is above 150 and the number during a weak month is often less than 30. After many years of studying these results, it was determined that the sunspot cycle reaches its peak approximately every 11 years and that these cycles have a great impact on radio propagation. Between these peaks are several years with very low sunspot activity. During years with high sunspot activity, the MUF dramatically increases and long-distance communications across much of the HF band is possible. During the peak of the last sunspot cycle, in 1989, the MUF was often above 30 MHz! When the cycle is at its low point, the MUF decreases and much less of the HF band is usable for long-range communications. Generally, the frequencies above 10000 kHz dramatically improve during the peak years of the sunspot cycle, and the frequencies below 10000 kHz are much less affected.

During years of high sunspot activity, the MUF dramatically

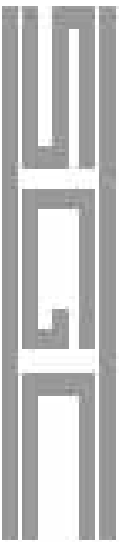

HF INTERFERENCE

Although the long distances that HF radio signals can be received is amazing, in comparison to the other radio bands, several types of distance-related interference can ruin reception or make listening unpleasant. The most widespread type of interference fits under the broad heading of noise. Noise consists of natural and man-made noise. Natural noise is produced by everything from thunder storms to planets (hence, radio telescopes). Thunder storms are the worst because they cause very loud crashes; because of the long distances that shortwave signals travel, the noise produced by thunderstorms is also likely to travel hundreds of miles (or further). Even if the weather is clear (you should never operate HF equipment during a local thunderstorm!), a distant thunderstorm could ruin your reception of a weak station that would otherwise be audible at your location.

Noise consists of natural (e.g. thunder) and man-made (e.g. fluorescent lighting) interference.

Man-made interference can arrive from a vast variety of sources. If nothing else, at least most man-made interference is limited in its range; most is limited to the building that the equipment is located in or to a several-block surrounding area. One of the worst causes of man-made interference is caused by fluorescent lights, which create a medium-strength buzz across the HF range, although it is often at its worst on the lower frequencies. In fact, fluorescent lights near an antenna can drown a normally usable signal. If your radio is located near computers, it will probably receive a light buzz across the bands and much stronger "bleeps." These interference problems are covered further in this user guide.

Adjacent-channel interference is a special type of man-made interference where a station from a nearby frequency is "washing over" or "splattering across" another. A somewhat similar type of interference is co-channel interference, where the interfering station is on the same frequency. A good example of co-channel interference is the 1400 to 1500 kHz "graveyard" region of the AM broadcast band in the evening hours, where dozens of signals are all "fighting" to be heard.

Other types of HF interference cause signal distortion from the propagational effects. One of the most interesting effects is polar echo, which occurs when one component of a radio signal takes an East-West path and another arrives over one of the poles of the Earth. Most every morning, one can tune into one of the BBC broadcast transmitters and hear the effect of polar echo. Because the signals take different paths, they arrive at different times, creating an echo on the audio signal. During the lightest effects, the voices sound a bit "boomy;" at worst, the delay is so long that the programming is difficult to understand. A related phenomena is polar flutter, where the signal passes over one of the poles and very quickly fades up and down in strength, creating a "fluttery" sound.

Fading is the most common form of propagational interference.

Fading is the most common and damaging form of propagational interference. The two most common types of fading are selective fading and multipath fading. With selective

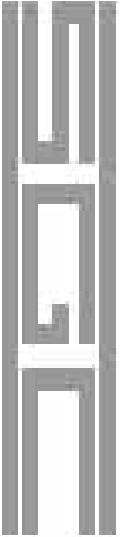

fading, the ionosphere changes orientation quickly and the reception is altered (somewhat like a ripple passing through the signal). Because of these effects, it is best to use the narrowest mode possible, if selective fading is a problem. As a result, FM and AM signals are especially prone to selective fading, SSB is slightly affected, and the CW mode is almost free from selective fading. The other type, multipath fading, occurs when signals take different paths to arrive at the same location. Multipath fading is a variation of polar echo; instead of the signals creating an echo effect, the phase of the signals are altered as they are refracted by the atmosphere. As a result, the received signal fades in and out.

The last major propagational effect does not actually cause interference to a signal; it absorbs it. Although sun spots are beneficial to propagation as a whole, solar flares destroy communications. During a solar storm, communications across a wide frequency range can suddenly be cut off. Many listeners have thought that their receivers either weren't working or that the exterior antenna had come down because virtually no signals were audible. Instead, they had turned on their radios during a major solar flare. On the other hand, other listeners had thought they were listening during a solar flare, but actually didn't have their antenna connected or they had tuned their radio above the MUF or below the LUF.

SIGNAL PATHS

As covered in the preceding section, signals take various routes to travel to a receiver from the transmitter. The problems that can result from signal paths include polar flutter and echo, and multipath fading.

The signal path is also important when attempting to contact or receive signals from a particular area. When you receive a signal, you can typically assume that it took the shortest path to reach you (i.e. you could connect the points between the transmitting and receiving locations with a line on a globe). This is known as short-path reception. Exceptions to this rule occur when two or more different paths are nearly the same distance (such as the BBC example of polar flutter, where the north-south path isn't much longer than the east-west path).

The other major signal path is the long path. The long-path radio signal travels the opposite direction from the short-path signal. For example, the long-path signal from the BBC transmitter (mentioned earlier) would be east: across Europe, Asia, the Pacific Ocean, most of North America, and finally it would arrive in Pennsylvania. As you can imagine, the signals received via long path are often very weak--especially if the long path was very long and the frequency is low. On the other hand, if the station is on the other side of the world and there is little difference between the long path and the short path, you could be receiving either or both. This case occurred recently to a listener on the east coast of the USA who was listening to a small, private broadcast station from New Zealand - 12 time zones away. At the same time he was listening to it, it was also being heard throughout North America and in Germany. Because the signals were generally a bit better in the West and Midwest, we can assume that he heard the Pacific Ocean-to-Western North America route, rather than the one that passed through Asia and Europe.

One of the most intriguing propagational anomalies is the effect of the grey line on HF radio transmissions. The grey line region is the part of the world that is neither in darkness nor in daylight. Because two grey-line stripes are constantly moving around the earth, the propagational alterations are very brief (usually only about an hour or so in length). Many amateurs and hard core radio listeners actively scour the bands at sunrise or sunset. The ionosphere is highly efficient at these times, so listeners can often pull in some amazing catches. Grey-line propagation is probably of far less interest to those who use the radio bands in conjunction with their occupation. If you are one of these users, chances are that grey-line propagation will be either a curiosity or a nuisance, as more stations that could cause interference to your signal become audible.

The Grey Line region is the part of Earth that is neither in darkness or daylight—the ionosphere is highly efficient at these times.

OPERATING NECESSITIES

Because HF communications are capable of covering such large distances and because they are so complex, you must plan out your system and your operating techniques in advance. Of course, in order to participate in two-way communications in the HF bands, you must have a receiver, a transmitter (these two are usually combined to form a transceiver), and an antenna. The type of antenna that you choose, the manner in which you construct it, and the ground system that it connects with are all key factors in the success of your operations. HF transceivers vary greatly in type, power, construction, frequency ranges, operating modes, features, etc., so you must be sure that you purchase a model that best suits your requirements. SGC transceivers and antennas are covered further in this user guide.

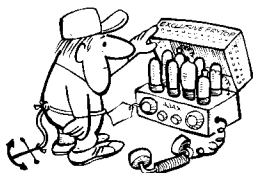

Depending on your location, the frequencies that you are allocated to use, and the distance from your contacts, the amount of power output that you will require will vary. In any case, only use as much power as necessary to make the contact. If you use more power, many more people will listen to your transmissions and (especially for amateur radio operators) your signal could cause interference in the over-crowded amateur bands. As a result, some transceivers, including some of those from SGC, allow you to continuously decrease the power output.

For privacy, and to avoid conflict with other signals, only use as much power as necessary to make the contact.

In order to effectively communicate on the HF bands, you will probably need to spend some time "studying" the propagational effects first hand. The best way to do this is to purchase or borrow an inexpensive general-coverage shortwave receiver or a transceiver, if you don't already own one. Install an antenna and listen across the shortwave bands. The shortwave broadcast stations are fun and interesting to listen to, but most use tremendous transmitter powers--often as great as 500,000 watts output! As a result, you cannot really assess the range of your signal (or someone else's) just by listening to these broadcasters.

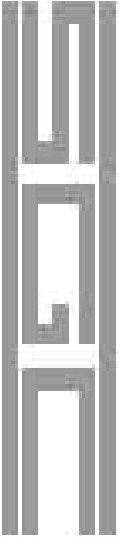

The best indications of the bands, the distance of skip, and the distances that you can cover are by listening to stations in the bands (the general frequency areas) that you will be working or by listening to nearby amateur radio bands. Some beacon stations operate in the amateur radio bands to provide radio enthusiasts with an as-it-happens guide to propagation conditions. Beacon stations usually transmit their call sign over and over in Morse code, according to a particular schedule (often 24 hours per day). If you listen to these beacons, know the power and locations, you can use them as an accurate yardstick to measure the conditions. If you are an amateur radio operator, you can check into several nets (networks) and ask those involved for an outlook on the present and upcoming propagation conditions.

Use beacon stations to determine broadcast

Listening is one the most important aspects of having successful operations. It might not make a difference if you are using a 30-watt transceiver to communicate with someone a few miles away, but radio experience and good listening skills are a must for long-distance communications. Because of the static, fading, and interference that sometimes plagues the HF frequencies over long distances, you must be able to mentally "filter out" this noise. Experienced "ears" are able to log relatively low-powered AM broadcast outlets while the untrained listener wouldn't hear the broadcaster at all. It will sound like static to them!

INFORMATION SOURCES

In addition to gaining experience by listening to the HF bands, it is very important to keep up to date with various sources of outside information. The outside sources can be either in broadcast or written form. Some of the best amateur radio publications are available from the Amateur Radio Relay League (ARRL). The ARRL sells a number of excellent books of various aspects of the amateur radio hobby, and most of these books relate quite well to other HF radio services. In addition, the ARRL also produces one of the best amateur radio magazines, QST. For more information on the products and services available from the ARRL, contact: ARRL, 225 Main St., Newington, CT 06111, USA.

Some of the best amateur radio publications are available from the Amateur Radio Relay League

Another publisher of technical books is TAB/McGraw-Hill. In addition to selling a number of beginner-, intermediate-, and advanced-level books on electronics, shortwave, and computers, the company also offers one of the best antenna books available. Joe Carr's Practical Antenna Handbook (2nd Edition), covers most every practical antenna design with a down-to-earth approach. For a catalog, write to: TAB/McGraw-Hill, Blue Ridge Summit, PA 17214-0850, USA or call (800) 822-8158.

Two excellent annual guides to HF/shortwave broadcast listening are available. The World Radio TV Handbook features hundreds of pages of frequency listings, addresses, transmitter sites for AM, HF/shortwave, and television broadcast stations around the world. For more information, write to: WRTH, BPI Communications, 1515

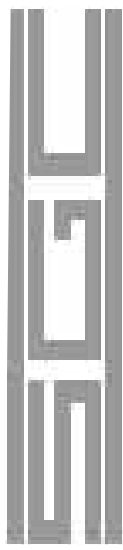

Broadway, New York, NY 10036, USA. The Passport to World Band Radio covers the same general topic as the WRTH, but it features less raw information and more interpretations of information and trends in international broadcasting. For more information, write to: Passport to World Band Radio, IBS, Box 300, Penn's Park, PA 18943, USA. Whether or not you are interested in HF/shortwave broadcasting, either of these books are invaluable if you need to discover what Latin American stations are fading into the 6200 kHz area marine frequencies or what African broadcasters are booming into the 40-meter amateur band.

Aside from QST, several other informative amateur radio magazines are available. CQ is now in its 50th anniversary and it is available on newsstands or from: CQ, 76 North Broadway, Hicksville, NY 11801, USA. 73 Amateur Radio Today, 70 Route 202 North, Peterborough, NH 03458, USA covers the amateur radio hobby, but seems to go more for the homebrewing/kit-building angle. All three of the major amateur radio magazines cover propagation from month to month, and they feature practical information about how to make the most of the varying HF conditions. Also, they all have interesting tips, modifications, and antenna projects to make your operating easier and more effective.

Several other magazines might be of interest to those who are interested in HF broadcasts or to government, military, or marine operators. Monitoring Times and Popular Communications magazines cover a variety of radio-listening topics and columns, from longwave through microwave communications. For more information, write to: Monitoring Times, 140 Dog Branch Rd, Brasstown, NC 28902, USA (800) 438-8155 and Popular Communications, 76 North Broadway, Hicksville, NY 11801, USA.

For more up-to-date information on the propagational conditions, you can listen to radio stations WWV and WWVH, which are the two time and frequency standard stations for the United States. Being a time station means both of these stations only broadcast time pips and the tone at the top the minute, along with announcements as such. WWV and WWVH are set to an atomic clock, which ensures that they are exactly on time. Being a frequency standard means that the stations are exactly on frequency, and they can be used to calibrate transceivers or frequency counters. WWV (from Ft. Collins, Colorado) and WWVH (from Kauai, Hawaii) both broadcast on 2500, 5000, 10000, and 15000 kHz. WWV also broadcasts on 20000 kHz. The two broadcasts are exactly the same, except that WWV features a male announcer for the time checks and WWVH airs a female announcer.

Every hour (at 18 minutes past the hour on WWV and 45 minutes past the hour on WWVH), the stations broadcast propagation reports. These reports are updated daily between 2100 and 2200 UTC and they are the most up-to-date information that is available (short of kidnapping an ionospheric scientist).

WWV and WWVH broadcast information about three different propagational factors: the A index, the K index, and the solar flux. The A index and K index are related values that reflect the amount of geomagnetic activity in the ionosphere. This explanation sounds complicated and it is. What is important to know is that the lower the numbers are, the quieter the conditions are; the higher the number are, the more stormy the ionospheric conditions are. If the A and K indexes are very low (0-10 for the A and 0-3 for the K), the propagation should be better. The last of the

announced WWV/WWVH propagation conditions is the solar flux. The solar flux is directly proportional to the sunspot number, so as covered earlier, the higher solar flux number (which would occur near the peak of the sunspot cycle) makes for much better propagation on the frequencies above 10000 kHz.

OPERATING MODES

Over the HF spectrum, a number of different operating modes are used for two-way communications. The operating mode is a format of the data and the manner in which it is transmitted. For example, although SSB and AM (covered earlier) are both in the voice format, they are transmitted in different manners. The following modes are used frequently across the HF spectrum.

MORSE CODE

CW (Continuous Wave) CW is a binary code that consists of "dits" and "dahs" as a transmitter is being keyed on and off. Although a number of different codes have been used since the days of the telegraph, the only one that is widely used is Morse code. All amateur radio operators who use the HF bands are required to send and receive Morse code at at least five words per minute (wpm). CW might appear to be outmoded now that today's computers can send and receive many types of digital communications reliably. However, the CW signal is very efficient because only the pattern of the signal (not the audio on the signal) needs to be understood and because the signal can be very narrow. As a result, CW is the most reliable form of communications for human operators.

VOICE

AM (Amplitude Modulation) As was covered earlier, the AM mode consists of a base carrier, a modulated upper sideband, and a modulated lower sideband. However, some of the newer transceivers that have this mode use the SSB signal with a carrier inserted to produce a faux AM signal. Although true AM is the favorite mode of AM band and shortwave broadcasters, it is rarely used elsewhere because it is inefficient and because it requires a large amount of space in the already-crowded amateur bands. For the most part, the only AM two-way stations currently on the air are nostalgic amateurs who love the broadcast-quality audio from this mode.

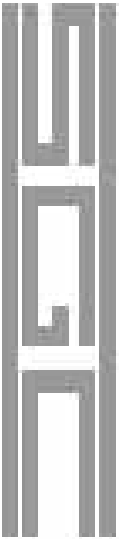

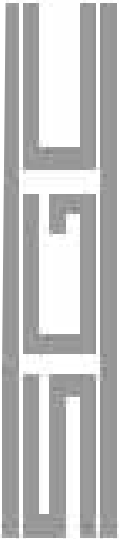

SSB (SINGLE SIDEBAND)

As was covered earlier, SSB is one half of the voice component of the standard AM signal. The SSB mode is nearly always used for two-way communications across the HF spectrum. SSB is so popular because the mode is much more efficient than any other voice mode and because the signals are narrower, so it is rarely hampered by fading.

DATA

RTTY (Radio Teletype) RTTY (often pronounced as "ritty") is one of the earliest forms of data communications. In this system, printed data is transmitted via a high-speed machine, rather than hand-keyed, as is the case with CW communications. Although CW is a form of data communications, it is copied by a human operator. Nobody can copy RTTY by ear. RTTY is a completely different world of communications from the voice modes. To try to thoroughly cover this topic here would be somewhat like trying to cover every aspect of DOS and Windows in one introductory book on computers. As a result, the information in the following paragraphs is only intended to provide some basic information and to whet your interest in this branch of the technology.

In order to send and receive RTTY, you must have other equipment in addition to the standard HF transceiver/antenna combination. Today, the most common arrangement would be to interface a personal computer with your transceiver and purchase the appropriate demodulating/modulating software or a computer interface. If no computer is available, then you are stuck with purchasing a modulator/demodulator (modem), a monitor, and a printer.

The three major branches of RTTY communications are Baudot, AMTOR, and ASCII. The characters in Baudot code are formed by blocks of five-digit binary codes and an initial arrow. There are "old-timer" amateur radio/MARS friends who who have Baudot RTTY units from the mid-century. These hulking blocks of steel are true mechanical wonders--something like a giant typewriter and printer combination in a desk-sized case full of gears. The catch with Baudot code is that it directly intermeshes with these mechanical printers and it is prone to interference--fades, static, and man-made interference, which cause errors in the received messages.

AMTOR is (simplified) RTTY Baudot code that has been modified to add various error-detection and correction enhancements. The AMTOR system corrects data by sending it in time-delayed chunks. The transceivers are connected to a "smart box"--a computer modulator/demodulator. Then, the transmitting station will send a block of data and the receiving station will receive it and transmit a signal back to verify that it received the signal. If the signals from the transmitting station are not received properly, then the receiving station will transmit a signal for the other station to repeat that block of text. This process will continue until the entire message is sent. Technically,

this transmit/receive/verify process is called handshaking.

SITOR is a version of AMTOR that is used especially for marine and weather information. As a result, SITOR is mostly important for marine operators. Some Coast Guard and Marine Coast stations operate in the commercial marine bands. Otherwise, some press frequencies in the 8 and 12 MHz bands are still audible. Just below the AM broadcast band on 518 kHz is a good bet for hearing U.S. Coast Guard information, which is broadcast to ships at sea.

ASCII is a very familiar term to many people in the 1990's because of the popularity of computers. Nearly every computer editing system uses ASCII or some derivative of ASCII. As a result, it makes sense that ASCII would also be used to communicate data on the HF bands. Like Morse code and Baudot code, ASCII is a binary code. However, it differs from Morse because it uses 0 and 1 in the code (instead of dots and dashes) and it differs from Baudot code because it uses a seven-digit instead of a five-digit code.

When speaking of digital transmissions, whether RTTY radio transmissions, or computer/modem transmissions, the baud rate is the speed by which the information is transferred. The baud rate is determined by the bits of information (each electrical impulse) that flow through the system. Typical baud rates for computers are 300, 1200, 2400, 9600, 14,400, and 28,800 bps (bits per second). By the mid 1990's, most of the transmissions were in the last three speeds. The baud rates for RTTY are generally much slower because of the lower quality for the transmissions (static crashes, fades, adjacent-channel interference, etc.). Most RTTY baud rates are 100 bps or less.

One of the most interesting forms of data communications is packet radio. Packet radio is so named because information is broken up into small packets and sent hither through the radio waves. Unlike the typical forms of data communications (where the send and receive process is very noticeable), packet radio is more like having a wireless computer BBS. The packet messages can be stored and recalled at a later date, the communications are relatively error-free, and the information can be sent to many interconnected stations.

The data transmissions are interesting and useful because they can be used essentially like E-Mail. RTTY doesn't have the advantages that it once had, now that the Internet has become "the information highway." Still, RTTY and packet radio are free to use if you are licensed to do so, and it's fun!

VIDEO

The most common form of video transmission is television. In addition to the broadcasts in the typical television band, special slow-scan television (SSTV) is also broadcast in the amateur radio bands. SSTV is different from regular TV in that the commercial TV broadcasts are actually Fast-Scan TV. SSTV is different from FSTV because the scan rate is much slower. That means that the screen is updated at a much slower pace than regular TV. As a result, SSTV is much more useful to transmit still images than moving images. Like the other forms of amateur

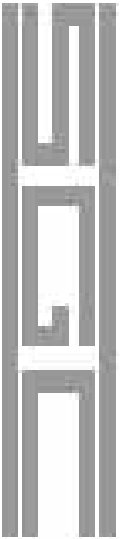

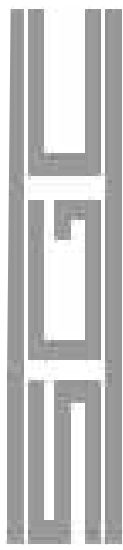

radio, only noncommercial, two-way communications can be transmitted, so don't expect to watch your favorite show on the SSTV frequencies. In order to send and receive SSTV signals, you would need a TV or TV monitor, a scan converter, and camera, in addition to an HF SSB transceiver.

One mode that is somewhat of a cross between a digital and a video mode is facsimile (fax). For most people, faxes were born in the 1980's; however, radio faxing goes back to the late 1920's, when the mode first experiments were taking place. Several years later, fax services, such as a special radio fax station that only transmitted the New York Times, were active. Like the standard telefax machines, radio fax sends the data line by line until the picture is complete. Some amateur radio companies are manufacturing relatively inexpensive modem units specifically to interface with computers and receivers so that you can send and receive faxes via the HF frequencies.

For more information on data and video communications, check out the annual ARRL Handbook for Radio Amateurs by the staff of the American Radio Relay League, Your Gateway to Packet Radio by Stan Horzepa, The RTTY Listener by Fred Osterman, The Guide to World RTTY Stations and The Guide to Facsimile Stations by Joerg Kingenfuss, The Weather Satellite Handbook by Dr. Ralph Taggart, The Packet Radio Handbook (2nd Edition) by Jon Mayo, and The Amateur Television Workbook by M. Stone.

HF SSB vs. VHF/UHF RADIO COMMUNICATION SYSTEMS

There are many situations in remote areas developing countries where HF systems offer superior performance at a lower cost than VHF and UHF communications systems. HF SSB communications is far more reliable--especially where mountainous terrain or distances over 14 miles are encountered.

VHF/UHF COMMUNICATIONS

The coverage of this manual is confined to the HF spectrum, but it is important to know about the other radio bands. For example, as you go higher than about 30 MHz, the radio spectrum starts operating a lot more like light; radio signals operate under the "line-of-sight" theory. Instead of being refracted by the ionosphere, as they do at the lower frequencies, signals at the higher frequencies (typically 50 MHz and higher) cut right through the ionosphere and into outer space. This is the same thing that happens when the MUF is low and the signals on the upper regions of the HF spectrum cut through the ionosphere. Because no "skip" can be relied upon (unlike on the HF frequencies), VHF and UHF signals typically do not travel long distances unless the towers are very high and very high powers are used. Although the signals in the regions above 30 MHz can sometimes skip hundreds of miles, this sort of propagation is very irregular and cannot be relied upon.

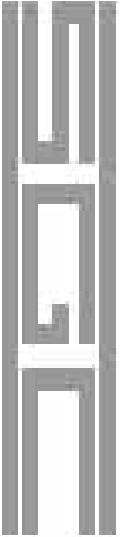

"Skip" is a key to understanding HF radio: at most any time of day, you should be able to transmit a signal to a given part of the world with a relatively small amount of power. Although these long-distance "skywave" characteristics make up the bulk of HF operations, don't ignore the ground-wave function of HF for short-range communications. The "perfect-signal" ground-wave range for HF frequencies depends on the season, the daily propagation conditions, the frequency chosen and the time of day.

Although the moon has been used to achieve great distances under experimental conditions using "moon bounce" VHF and UHF communications, the tracking requirements and the sophisticated equipment required render this type of communications useless for regularly scheduled radio operations.

COVERAGE

HF radio signals (2 to 30 MHz) can be received at distant locations using either ground-wave or sky-wave signals. Ground-wave signals follow the contour of the ground in hilly regions for 1 to 50 miles, depending on frequency. At distances greater than 50 miles to several thousand miles, sky-wave signals, which bounce off the F2 layer of the ionosphere are involved.

Ground Wave signals follow the contour of the Earth--in hilly areas from 1 to 300 miles.

Unlike HF signals, those in the VHF/UHF range do not follow the contour of the ground. Once again, the "line-of-sight" theory comes into play. If you are using a VHF or UHF communications system and are deep in a valley, your signal or that from the repeater might be blocked by the terrain. Or if you were in a city, tall buildings or other man-made objects could obstruct the signals. In cases such as these, your communications equipment would be rendered useless until you once again were back in the line-of-sight range of the receiving station.

Sky Wave signals can bounce several thousand miles off the ionosphere.

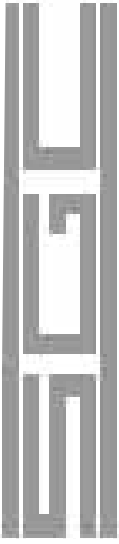

REPEATERS REQUIRED ON VHF/UHF

Because of the limited distance covered by VHF/UHF systems, most installations require some method of relaying signals UHF/VHF signals to establish reliable communications at significant distance. Typically, radio amateurs, commercial radio operators, and others, use a system of repeaters to relay these signals. A repeater is a transmitter, receiver, and duplexer combination that are connected to an antenna on top of a tall tower.

The first step of repeater operation is to transmit a message via a handheld transceiver that looks something like a cellular phone. The signal from the handheld is received by the receiving portion of the repeater. Then, the output from the receiver is fed directly into the transmitter, which transmits the signal with more power and with a taller antenna. The duplexer isolates the receiver and transmitter and allows one antenna to be effectively used for both receiving and transmitting. Although it might appear that the repeater transmitter would be transmitting continuously (whether or not anyone was being relayed), it's not; the strength of the input turns on ("keys") the repeater's transmitter.

Repeater-type VHF/UHF operations are much more costly than comparable HF systems in many situations. Repeaters require installation on the highest possible terrain, power source, tower(s), and a building to house equipment. This high terrain can cause problems because if no such land is already owned, it must be purchased. Then, a permanent building must be constructed to house the repeater and a power system (probably power lines or a generator power system). In order to construct this system, land (for the repeater site) and a road might need to be cleared. Depending on country, weather (such as high winds and extreme temperatures) can also force changes in the system design.

Aside from the costs, one of the worst aspects of VHF/UHF repeater use is that the locations are vulnerable. In the case of HF communications, the transceivers are taken to each site by the operators. The transceivers and antennas can even be installed in a car or carried in a backpack unit. With a repeater, the portable units are handheld or mounted in a vehicle, but the repeater site, the most important, expensive, and powerful link in the system, is abandoned and vulnerable to anyone who might want the equipment or the site. Therefore, consider the physical security if you plan to use VHF/UHF repeaters.

You should allocate the same level of security to a critical repeater site as you would give to a critical central telephone exchange or satellite ground station. Your communications are of crucial importance, and a UHF/VHF system is only as strong as the weakest link.

NO REPEATERS WITH HF SSB

HF single sideband technology has been a dependable system for more than 50 years in various international communications services on frequencies allocated by the International Telecommunications Union (ITU) for commercial telephone and data services and within individual countries, as permitted by treaty. SSB is the mode of choice by leading military organizations and international airlines, which use HF SSB to keep in contact with units on the move throughout the world.

A typical fixed HF SSB installation consists of a transceiver and an antenna, which could be a short vertical or a 20 to 90 foot wire suspended from a tree or rooftop. Mobile installations use an efficient 9 foot whip antenna. No repeaters are required for communications that range from local to intercontinental.

**SSB has become
the modern choice
for communications
in general.**

The range varies, depending on the frequency used. In the daytime, higher frequencies are used for long-range communications. This is because the F2 layer (one of several major layers) of the ionosphere, which reflects HF radio signals, lowers at night. This daily movement of the F2 layer is also why distant stations can be heard at night on the AM broadcast band.

SECURITY

Single sideband technology requires a more sophisticated receiver to intercept signals than VHF/UHF systems, which use simple FM signals. Although the SSB mode is somewhat common among amateur operators, it inherently provides some security of communication. This is the "cartoon duck" sound (when listening on a typical shortwave receiver) that was mentioned in the first section of this user guide. Also, several different types of scrambling devices (such as the SG-1703 high-security scrambler) are available.

Repeater systems are prone to be misused unless some radio security feature is placed on its input. If others learn of the repeater in the area and decide to use it for themselves, they only have to determine the input (receive) frequency of the repeater and transmit a signal on that frequency. Then, their signal will be re-transmitted by the repeater. Such communications could be used with harmless or malicious intentions.

To avoid these problems, repeaters sometimes have a decoder in the repeater. In this case, a code will be transmitted by the handheld unit before any communications occur. A correct code will turn on the transmitter and allow the repeater to relay the signals.

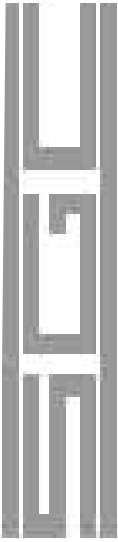

POWER

In mobile HF communications systems, you probably won't even notice that power from your vehicle's motor is being used. That is because your vehicle's alternator is producing a set amount of power, whether or not any

In mobile, a separate battery should be dedicated to the HF-SSB system.

accessories (heater, air conditioning, lights, etc.) are being used. Likewise, even if you are transmitting continuously, you probably won't notice any difference in performance between that and driving without the transceiver.

Regardless, for any portable or mobile HF installation (marine, commercial, amateur, etc.), SGC always recommends that a separate battery (or several) be devoted to the radio system. This works to your advantage in several ways. If the radio needs more power, a second battery is in reserve. If you need more power to start an engine, reserve from the second battery can be used. Or if you are in an emergency situation with a nonfunctional vehicle, you will have plenty of battery power to transmit for assistance.

An 80 AH gel cell battery will provide a healthy mobile operation.

INSTALLATION

The base station installation for HF SSB systems is generally quicker than VHF/UHF repeater systems because of the different antennas that are required. An HF wire antenna can be easily hoisted into position with a rope in just a few minutes. On the other hand, VHF/UHF antennas generally require a tall tower to reach an appropriate operating elevation (thus, the new tower, in addition to the antenna, must be installed).

The HF portable antenna systems are typically also simple to install. SGC produces The SGC Quick Mount System (QMS) in conjunction with the SG-230 antenna coupler and SG-303 high-performance antenna allows a mobile vehicle installation within 15 to 20 minutes. This is slightly longer than the 10 to 15 minutes required for a mobile VHF/UHF installation using a magnetic mount antenna. The trade off is the superior range, regardless of terrain and lower initial overall system cost provided by HF SSB.

UHF/VHF magnetic mountings are usually not strong enough for commercial service, thus you might need to drill a hole in the car body. Not only is the Quick Mounting System strong and easy to install, but you can just as easily remove the system and place it on another vehicle.

COST

It is appropriate to consider costs on a side-by-side basis when selecting a communications system for use in a developing country. In addition to the cost chart on the following page, you should also consider the long-term uses for equipment as needs of the country change during development. HF radio equipment used by paramilitary forces can be re-used in public civil services in remote field locations with little expense, other than moving relatively portable HF antennas.

Moving the VHF/UHF equipment will generally involve moving towers, buildings, repeater equipment, the power supplies for the repeaters, and the individual fixed or mobile units. In addition, new antenna height/coverage studies will have to be made to find the best locations for the new repeater sites. Then the land will have to be purchased and the process of clearing land and installing equipment will begin again.

Installation comparison study:

	HF SSB	VHF/UHF
Base Stations Available	Yes	Yes
Portable Unit Available	Yes	Yes
Repeater Required	No	Yes
Tower Required	No	Yes
High Elevation Desirable	No	Yes
Repeater Building Needed	No	Yes

Cost Comparison Study:

Three base stations, each 50 miles apart, need to be in communication in hilly terrain. The following would likely apply:

HF SSB		VHF/UHF	
3 Transceivers	\$6,000	3 Transceivers	\$6,000
3 Antennas	\$1,350	2 Repeaters	\$9,000
3 Antenna Masts	\$300	5 Towers	\$9,000
		2 Repeater Sites	\$??
		2 Repeater Bldg.	\$4,000
		2 Repeater Power	\$6,000
TOTAL	\$7,650	TOTAL	\$34,000 + site cost

As you can see in this type of installation, HF SSB has a tremendous cost advantage over VHF/UHF alternatives, where long distances (over 12 miles) are involved.

CHAPTER 2

**HF TRANSCEIVER
SPECIFICATIONS
AND FEATURES**

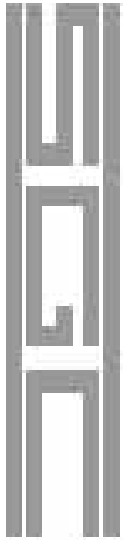



HF TRANSCEIVER SPECIFICATIONS AND FEATURES

Many different specifications and features are available for the various HF transceivers on the market. A specification is an aspect of a transceiver that is inherent in the radio, yet can vary from model to model. An example of one of these specifications is the frequency; every radio has a frequency range, but some cover the AM broadcast band, others cover the HF band, some cover microwave frequencies, etc. Even the coverage range of HF radios typically varies. One common range is 1600 to 30000 kHz (1.6 to 30 MHz), but some radios only cover 2000 to 12000 kHz (2 to 12 MHz).

A feature is an addition to the radio that wouldn't necessarily have to be there for the radio to function. However, features generally either allow greater flexibility, provide you with convenience, or improve the operation of the radio. One example of a feature is an attenuator, which limits the strength of the signals that enter the receiver. Many radios don't have attenuators, but they can be handy to have in certain receiving situations.

MODES

The modes of operation for a transceiver were covered earlier in this user guide. Some of the most common modes include CW, AM, SSB (LSB and USB), and FM. The available modes vary from transceiver to transceiver.

TRANSMITTER / RECEIVER BANDS AND FREQUENCY RANGE

This point was covered as an example for this section. However, the frequency range is the part of the radio spectrum that your equipment is capable of covering. Most radios break this coverage up into different bands--portions of the radio spectrum. Bands were important decades ago, when changing meant that you switched between different components in the radio for better operations or when numerous bands meant that you wouldn't have to turn the knob so many times to get to a given frequency. With today's synthesized tuning, the number of bands is relatively inconsequential.

POWER OUTPUT

The power output is the number of watts that the transmitting portion of the transceiver will send into an antenna. This figure differs considerably from the input power or the PEP power ratings of a transmitter. Typically,

the power output is approximately 50% of these figures, even though all types are frequently listed for transceivers. Also, the power levels are a logarithmic function, not a linear function. For example, a transmitter with a 50-watt output is not half as "strong" as a transmitter with a 100-watt output. A 10-watt transmitter is half as "strong" as a 100-watt unit ($10 \times 10 = 100$).

Power Output is the number of RF watts that the transmitting portion of the transceiver will send into the antenna.

FREQUENCY STABILITY AND CRYSTAL OVEN

Frequency stability is of utmost importance with an SSB transceiver. All transceivers have a certain amount of drift when they warm up (especially) and are operating. Older units, such as the much older tube transceivers, could often drift as much as 1 kHz in an hour while warming up and operating. Because SSB has a narrow signal and when you slightly tune off of the center of the signal it sounds duck-like, SSB transceivers can only drift a tiny amount. A crystal oven is a constant-temperature component that holds the frequency of a radio on a particular channel, without drifting.

Frequency Stability is critical with an SSB transceiver.

FREQUENCY STEP

The frequency steps for radios have only come about since the advent of digital, synthesized tuning. Before, you would tune the radio continuously through the radio bands. With digital tuning, you must tune the radio in steps. Because of the varying frequencies of radio stations (especially with quite a bit of the older, analog equipment still in use) and because of the effects of interference (damaging part, but not all, of a signal), it is best for the digital receiver to be able to tune in increments as small as possible. However, for convenience, it can be handy to tune across the bands in other steps, such as 5-kHz steps for tuning across the shortwave broadcast bands (most shortwave broadcasters are separated by 5 kHz).

SENSITIVITY

The sensitivity of a radio receiver is the amount of signal that is necessary for the receiver to distinguish it as a signal and not as noise. The difference between a receiver with excellent sensitivity and one with poor sensitivity is that you will not be able to hear some weak stations on the receiver with poor sensitivity. As a result, sensitivity is important when monitoring the HF spectrum or when communicating over very long distances.

Sensitivity is the amount of signal needed for the receiver to distinguish it from the background noise.

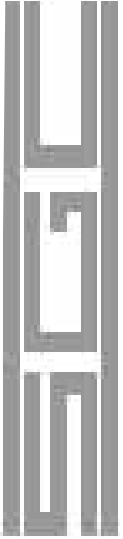

SELECTIVITY

The selectivity of a radio receiver is its ability to distinguish between signals that are audible on the frequency that the radio is tuned to and other signals across the radio spectrum. Sensitivity is especially important when you are listening to crowded parts of the radio spectrum. If this is the case, you will hear one station on a radio with good selectivity and many stations (or images of stations) on a receiver with poor selectivity.

OPERATING TEMPERATURE RANGE

The operating temperature range of a transceiver is simply the temperature range that it will operate within. This measure is especially important when the equipment is to be used in extreme climates, such as in subzero or high temperatures near the equator.

POWER REQUIREMENTS

The power requirements of a radio refer to the voltage that it requires to operate. This voltage requirement is important because it will determine the power source that can operate the radio. Some of the common ratings are 220 and 110 volts (for operation from the main power lines) and 12 and 24 volts (for operation from a battery pack).

CURRENT DRAW

The current draw refers to the amount of power that a radio requires while operating. The equation $W = I \times V$ shows the relationship between the voltage, the wattage, and the current draw, where W is the power in watts, I is the current in amps, and V is the voltage in volts. For any radio that you use, V will be constant. When the voltage is constant, and the radio requiring more watts when receiving than transmitting, you can determine the difference in the current draw.

DUTY CYCLE

The duty cycle refers to the amount of time that the transmitter portion of the transceiver is operating at peak output. Even when a transceiver is transmitting Morse code, it is not running at a 100% duty cycle; the transmitter is off the air between every "dot" and "dash." SSB also operates at a lower duty cycle because the output fluctuates with the voice audio--the transmitter is only hitting peak output on the voice peaks and is basically off between words. AM has a much higher duty cycle because the carrier is on constantly and the audio signal is on as well. The duty cycle ratings are important when the transmitter will be used for long periods of transmitting, such as for broadcast transmitters.

Duty Cycle is the amount of time the transmitter is operating at peak output, and is the percentage of the Transmit time to the receive/rest of a transmitter.

DISPLAY AND ILLUMINATION



Modern transceivers don't have the frequencies printed out on tuning drums or slide rules and the functions aren't controlled by knobs and switches, like their early predecessors. Instead, modern transceivers often have buttons and digital tuning. The frequency readout as well as all of the functions of the radio appear on the display of the radio. Thus, it is a must to be able to see the display on modern transceivers. Illumination allows you to see the display in the dark and not be "blind." Displays are very important in modern radios; some displays are tiny and poorly lit. You need a large well-illuminated display so that you can use the radio capably in even the worst circumstances. The SG-2000 has strong backlighting and the frequency readout is one of the largest on the market.

METERING

The meters on a transceiver show different aspects of the transmitter's or receiver's operation, such as: the signal strength of the received signal, the power output of the transmitter, the SWR between the transmitter output and the antenna, and the voltages or current levels at various locations in the transmitter.

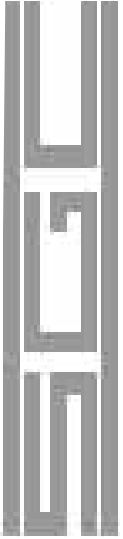

MEMORIES

With the memories in a transceiver, you can enter a frequency via a button; when you press that button the radio changes to that frequency. Most radios have a number of memories and with them, you can quickly scan through a range of important frequencies.

SCAN

If you press the scan function, the radio will tune across a range of frequencies and stop on the strong signals. This function is important for amateur operators (who might want to find a strong signal to contact) and shortwave listeners (who might want to casually listen to a strong shortwave program).

ALARM

On a portable radio, an alarm can be set to alert an operator to make a contact at a certain time or to monitor a certain frequency. Although alarms are quite common on watches and clocks, a built-in radio alarm can be quite helpful in many situations.

AUTO ALARM

In contrast to the alarm, an auto alarm on a marine radio is an automatic distress signal. On the SG-2000, you only need to press the two red buttons on the front panel at the same time and an emergency distress signal will automatically be transmitted on the international distress frequency, 2182 kHz or any frequency of your choice.

BREAK-IN KEYING (QSK)

With this type of operation, the receiver will turn on during breaks in the continuous operation of several modes. For example, the receiver will activate during "dots" and "dashes" of a Morse code transmission or between the words of an SSB transmission.

SIDETONE

When Morse code is being sent, the transmitting portion of the transceiver is being keyed on and off. Your transmitter could produce no sound or an unpleasant sound. As a result, most transceivers contain built-in sidetone oscillators, which produce a more pleasant and easily copied tone during CW operation.

FILTERS

Filters control the amount of radio frequency spectrum that can be received at once: The Passband.

The filters in a radio control the amount of the radio spectrum that can be received at once; this amount of spectrum that you hear is known as the passband. For high-fidelity shortwave broadcasts in the AM mode, filters that are between 8 and 15 kHz wide are used; for general or weak-signal listening, filters that are between 2 and 6 kHz wide are used; for CW signals, filters that are between 0.5 and 2 kHz wide are used. The cut-off shape of the filter is also very important. If the filters cut out an exact portion of the band, they are operating properly. However, less-expensive filters allow more of the adjacent-channel "slop" to be received. The filters are one of the most important features in a receiver or in the receiving portion of a transceiver.

DSP (DIGITAL SIGNAL PROCESSING)

Digital signal processing (DSP) is a technology that is rapidly revolutionizing all aspects of the electronics industry. Digital signal processing, will probably revolutionize at least some aspects of this world. DSP may have much the same effect that personal computers had on everyday life in the early 1980's (in part because DSPs are computer-related).

DSPs are effective in many different configurations and applications (such as in medical electronics, diesel engine tune-ups, speech processing, long-distance telephone calls, music processing and recording, and television and video enhancement).

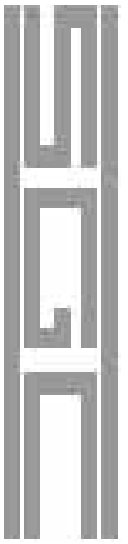

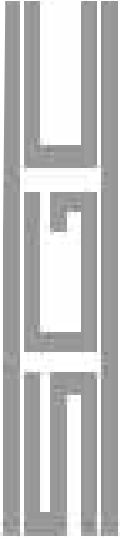

DSP IN HF COMMUNICATIONS

The DSP revolution has not yet taken over the planet, but it has begun. Digital transmissions are nothing new; Morse code, which is a binary alphabet, is approximately 150 years old. Another technological development that people assume is recent is the fax. Actually, the fax (facsimile) had been successfully used via the radio nearly 70 years earlier. At various times in the 1930's and 1940's, some shortwave radio stations broadcasted a particular newspaper via radio fax. For example, if you lived in the Eastern United States in the post-war 1940's and had a radio fax printer, you could have received the New York Times via their own fax station. Because of the high cost of technology, fax machines weren't feasible until the advent of the personal and business telephone-based fax machines in the 1980's.

Like binary codes and facsimile, DSPs have theoretically existed since the early 20th century. Actually, DSPs aren't any particular technology. DSPs are only a manipulation of a digital signal. Although DSPs sound like a spectacular magical, mystery, the term is actually very broad and very general--somewhat like the way that "wheeled vehicle" describes everything from a red wagon to a motorcycle to a train to an airplane. As a result, a box that digitally alters the acoustics of a symphony recorded on CD is a type of DSP and equipment that digitally eliminates the time-delayed echo in telephone lines is another type of DSP.

Two reasons why all of this technology is being lumped together is because it's new and it will take a few years before the different branches spread out and because the DSPs all use many of the same DSP chips for different applications. The difference between the applications aren't the DSPs alone, rather it's what we "tell" it (program it) to do. As a result the lines that we draw and the general category of DSPs is extremely broad.

DSP TECHNOLOGY

DSP (digital signal processing) is a technology that is used to set different filter positions and to eliminate some forms of interference. Standard audio filters pull out a certain range of audio, called the passband. To eliminate adjacent-channel interference, a traditional analog receiver incorporates narrower filters that allow a smaller passband to be heard. With the smaller passband, less audio from other signals can interfere with the signal that you are listening to. The only problem is that as the filter positions are narrowed, less audio can pass through and the signal will sound muffled. Some extremely narrow CW filters pass so little audio that they are basically useless for any voice communications.

The basis of DSP is entirely different from analog radio operation. Instead of narrowing segments of audio electronically, DSP processes the sound digitally. To do this, all of the sound from the receiver is converted into numbers, or bits.

The DSP processes these bits. Different computerized algorithms determine whether some of the signals are noise, interference or the signal that you want to listen to. The noise is sampled and the processor in the DSP will "realize" that these numbers aren't part of the signal that you want to listen to; consequently, the numbers are tossed out and not processed into audio. Depending on the type of DSP that you are using, you can control it to eliminate quite a bit of background noise and local interference. Unlike the analog filters, which had performance that depended upon the quality of the materials and the construction, the performance of the DSP is essentially dependent upon the quality of the algorithms that are programmed into the EPROM chips.

After some of these numbers are thrown out, the remaining numbers have to go back through the conversion

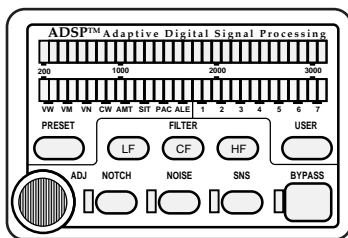

process. Here, the numbers are converted to sound, which is a complicated process. The numbers all represent the frequencies, timing, and loudness of the actual audio output. At this point, the numbers go through the digital-to-analog converter, where the sound is passed to an audio amplifier. The amplifier makes the signals strong enough to power the speaker. The speaker then changes the electrical impulses into audio.

The filter width is still important, no matter whether you use DSP or not. However, in the past, expensive mechanical filters were necessary for excellent receiver performance. If less expensive materials were used, the filters did not have a sharp cut-off and nearby signals would still interfere with the station that you were listening to. However, DSP units have different filter positions and they have sharp cut-offs, representative of expensive analog filters. Some DSPs even have a variable bandwidth so that you can tune the filters to exactly the width that you need and effectively have the benefit of dozens of analog filters.

Presently, most DSP units for radio are stand-alone accessory boxes. Several companies, such as SGC, are pioneering the use of built-in DSP in transceivers. Presently, SGC has two ADSP (automatic digital signal processing) heads available for the SG-2000 and is developing proprietary technology trademarked ADSP™ (Adaptive Digital Signal Processing™) and SNS™ (Spectral Noise Subtraction™). In a few years, a radio without DSP will seem as archaic as a transceiver without digital readout today.

SPEAKER/HEADPHONE/RECORD OUTPUTS

Most HF radios have audio outputs for external speakers and headphones. External speakers are important for convenient and group listening, and headphones are important for weak-signal or high outside-noise listening. Recording outputs can be important for recording contacts or conversations.

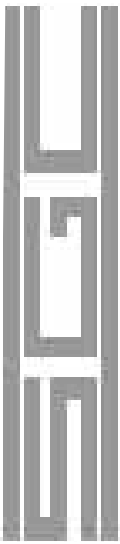

AUDIO I/O PORTS

The audio I/O ports on a radio enable it to be connected to RTTY modems. With the audio I/O port on the SG-2000, you can easily send and receive data communications from other stations.

AGC (AUTOMATIC GAIN CONTROL)

Automatic Gain Control (AGC) keeps receiver signal constant to compensate for fading and propagation variations.

Because of fading and static crashes, AGC is necessary to keep the volume of the receiver somewhat constant. Otherwise, the fade or static crash would suddenly blast through, and either make listening unpleasant or force you to keep your fingers on the volume control.

NOISE BLANKER

Noise Blanker. Eliminates very short, very loud interfering signals.

Very short, very loud interfering signals can be quite annoying when listening to the radio. The noise blanker silences the receiver during very brief periods when a sudden blast of noise appears. The receiver immediately turns on again and everything happens so quickly that you can't even tell that the receiver was turned off momentarily. The noise blanker isn't effective against long, loud noises because all of the sound is muted equally.

FREQUENCY OFFSETS

The difference in frequency between the receiver and transmitter is the frequency offset. In some transceivers, you can set the receiver frequency and the transmitter frequency separately, then there is sometimes a great frequency offset. In other cases, such as the difference between a CW receiving and transmitting frequency, the offset is very small.

PTT (PUSH-TO-TALK TRANSMITTER)

With the PTT transmitter function, you can push a button on the microphone and turn on the transmitter until you let go or unhook the switch.

VOX (VOICE-ACTIVATED TRANSMITTER)

With the VOX transmitter function, the transmitter will turn on whenever sounds of a certain loudness activate it. Thus, it allows hand-off operations and you can listen as long as you want until you feel like talking, which will activate the transmitter and be transmitted.

SPEECH PROCESSING

The speech processing function of a transmitter alters your voice as it travels into the microphone. The speech processor isn't a voice scrambler, but it will trim the high and low frequencies off of your voice and allow it to be more easily understood over the radio.

ATTENUATOR

The attenuator was also used as an example at the beginning of this section. Its function is to reduce the amount of signal that is received at the receiver. As a result, the attenuator function is handy if you are listening to a radio station that is extremely close and/or powerful.

SIMPLEX/DUPLEX OPERATION

These forms of operation are all related to being able to transmit and receive at the same time. With simplex operation, you can either receive or transmit. With duplex operation, you can transmit and receive at the same time (usually via the use of split channels).

SQUELCH

If you listen to the HF bands for extended periods of time, waiting for a station to appear, the background noise could be very annoying. The squelch function is a headache preventer; it turns off the audio of the receiver until a signal with sufficient strength turns the audio on.

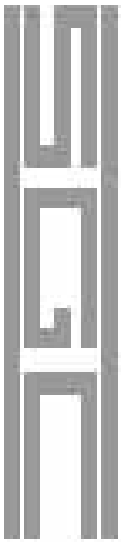

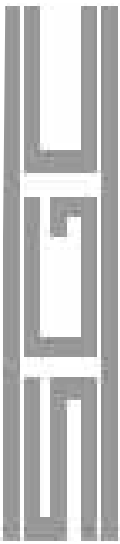

SPLIT-FREQUENCY OPERATION

With split-frequency operation, the transceiver allows you to tune the transmitter and receiver separately. This function could help your communications to be more secretive.

SELECTABLE SIDEBANDS

Most base-station equipment will allow you to choose which sideband (LSB or USB) that you want to operate (receive or transmit) with. However, some transceivers, especially those that are backpack or handheld units, only allow you to use one of the sidebands (usually USB).

DATA TRANSMISSION

Data is the flow of information, usually from a binary code, over the radio. A transceiver that is data compatible has an input and output for such communications. For the most part, only the newer, digital transceivers are data ready.

COMPUTER CONTROL



Some receivers and transceivers can be controlled via computer software. That is, the unit is interfaced into the radio and the software can do such things as change the frequencies, scan, analyze the audio and RF signals on the passband, activate an audio tape recorder, etc. Computer control could be important if the transceiver is part of a complicated communications network.

REMOTE CONTROL

With remote control operation, a control head is kept at a location where any functions or changes would be entered and the transceiver would remain at the installation site, connected to the power and antenna. Such a system would be particularly useful for marine operation, where several control heads could be located around a ship so that the operator could remain in contact via the radio no matter what other work needed to be completed.

ALE (AUTOMATIC LINK ESTABLISHMENT)

ALE is a form of data communications that is combined with DSP to form a sort of super radioteletype. Because of various error-detection and correction procedures, the data communications are relatively error-free. Also, the ALE controller is able to scan segments of the radio spectrum, in search of other ALE signals. If it finds one, it will automatically link up and is able to communicate immediately. If the ALE communications are broken by either deliberate or unintentional interference, the ALE controllers will automatically relink on another frequency.

ENCRYPTION AND SCRAMBLING

Many thousands of people around the world have shortwave receivers and regularly tune through the HF bands. If your communications must be secure, then you should use encryption or scrambling methods to protect your information. Encryption is the deliberate alteration of the data in a message (such as having code words that mean different things) to confuse any listeners. Scrambling is the electronic alteration of a signal to render it uncopyable to anyone who does not have a proper descrambler, or know the proper descrambling algorithms.

GENERAL-COVERAGE RECEIVE

Most transceivers for amateur radio are only capable of transmitting within the HF bands, to discourage out-of-band operation. However, if your transceiver is not able to receive outside of these amateur bands, you would have to purchase a general-coverage receiver just to listen to other frequencies. With the general-coverage receive feature, you can listen from (typically) 1600 to 30000 kHz (1.6 to 30 MHz) on a ham-bands only transceiver.

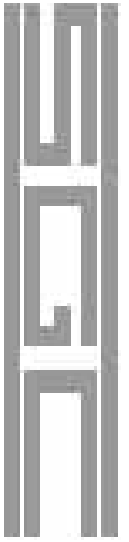

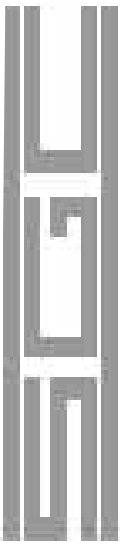

CHANNEL OPERATION

The military, marine, and aeronautical services typically operate on specific channels. A channel is a frequency that has been chosen for specific operations. For example, the television and CB channels are all frequencies that are spaced a certain distance to avoid interference with each other. In these circumstances, it is easier to flip through the channels, rather than have a standard tuning dial to adjust and readjust. HF transceivers for these purposes have certain channels to flip through, which makes operation, especially for novices, easy.

Channel Operation: A frequency that has been chosen for specific operations (military, marine, etc.).

POWER SUPPLIES

One of the important, but often neglected, aspects of HF communications is the power supply (both the actual power supply of the transceiver and the power source that provides power to the power supply). Most modern transceivers run on 12 Volts DC (direct current). With the exception of AC mains power supplies, many other

Most modern SSB transceivers run on 12 volts DC.

systems directly supply suitable DC voltages to run a radio. However, voltage regulators might be necessary for solar and wind-powered systems because their regulation is difficult. Solar, wind, and human-powered systems are all interesting because they can provide a creative and cost-effective approach to powering an HF station.

Another important consideration is how the power is moved from the power supply to the radio. This route can have a very high impact on radio performance--especially when transmitting.

CABLING

Regardless of the type of power supply used, you should design cabling from the power supply to the radio to minimize the voltage loss. This loss occurs because wire is not a perfect conductor of electricity. The longer the distance between a power supply and a radio, the greater the voltage drop will be.

Keep the Power Supply within 25 feet of the radio, preferably within 6 feet.

SGC does not recommend placing a power supply more than 25 feet from a radio. There are two reasons for this: First, the voltage drop that is experienced over 25 feet, even when large conductor cabling is used, is not acceptable because the performance (such as a lowered transmitter output power) can decline. Second, the longer the power cabling, the more chance that it will fail because of any number of unforeseen circumstances.

The electricity in wire behaves somewhat like water in a garden hose. The pressure of the water is analogous to

MINIMUM WIRE GAUGE RECOMMENDATIONS:
DC INSTALLATIONS

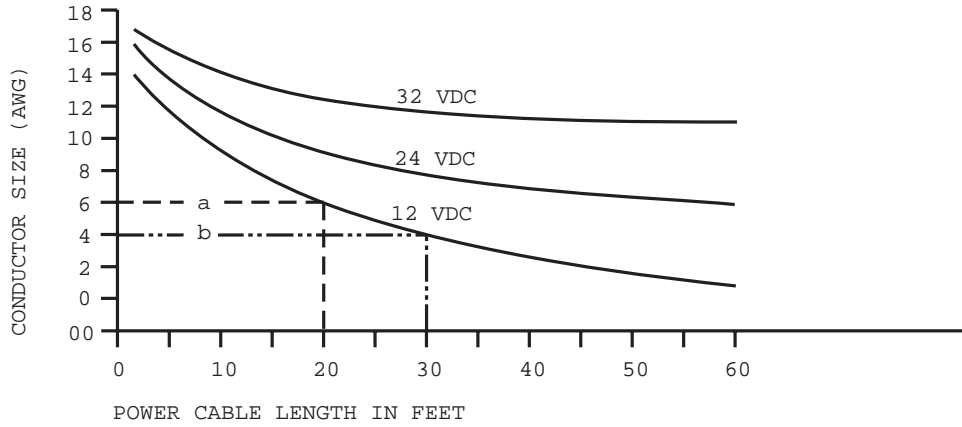

EXAMPLE:
a/ 100W SSB gauge 6 for 12V operation
b/ 150W SSB gauge 4 for 12V operation

voltage (electrical "pressure"), the internal friction of the hose is analogous to wiring resistance and the size of the hose is analogous to size of the wire. (By the way, the water faucet is equivalent to a switch, too.)

When electricity flows from the power supply to the radio at low current levels, the internal resistance of the wire has little effect. But as current increases, the voltage drop becomes more pronounced. Remember the garden hose? When you shut off the nozzle, the hose pressure is high. The voltage in the wire is also high. But turn on the nozzle, and the pressure along the hose drops; and you can get only so much water through the hose.

Now apply this effect to your power wiring: Turn on the radio a little bit, such as the receive mode where little power is drawn, and things will likely be just fine with #16 or #14 wire at 25 feet. But turn on the transmitting portion of the transceiver and nothing will work correctly because the voltage will drop dramatically.

Having power cables which are too small is like trying to fill a storm drain with a garden hose--it can't be done properly without doing something to keep the storm drain from working and doing its job.

Let's consider wire sizes between the power source and the radio. At 25 feet, we recommend #6 wire. At 12 feet, we also recommend #6. At 2 feet, we recommend #8, but we use #6 because it's more in line with our practice of building tremendous margins into all SGC products.

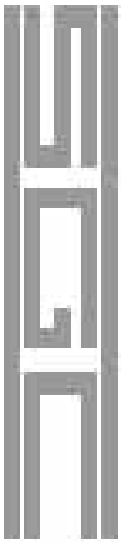

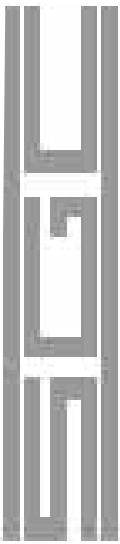

AC (MAINS) POWER SUPPLIES

There are two ways to convert 110 or 220 volts AC to 12 Volts DC, the most common DC input voltage for transceivers. The typical methods are via conventional transformer-rectifier power supplies and switching-type power supplies.

SGC does not recommend switching-type power supplies for continuous commercial service for two reasons: First, unless the switching power supply is of exceptional design and properly installed, it will generate RF "hash," which will create a high local noise level. Second, switching-type power supplies tend to fail when used in continuous-duty operation.

**We recommend
Transformer-Rectifier
power supplies.**

Some switching power supplies are quite good. Unfortunately, they are also very expensive and are not as cost effective as transformer-rectifier type power supplies.

**A Regulated power
supply will hold an
output voltage constant
over a wide range of
input voltage and output
load conditions.**

Many transformer-rectifier power supplies are of the regulated type. This means that they will hold an output voltage constant over a wide range of input voltage and output load conditions. If regulated power supplies are not well designed, they can also create RF "hash." This interference will create a buzz when the equipment is receiving; if the problem is severe, a bit of this distortion could also be present in the audio when transmitting. For this reason, SGC recommends the PS-50 regulated power supply if high current demands (such as those encountered in operation of a transceiver) are expected.

TRANSFORMER-RECTIFIER SUPPLIES

Transformer-rectifier power supplies are by far the most reliable available. They are able to operate over a wide range of input voltages and offer resistance to failure under periodic overload conditions, which would cause a switching-type supply to fail.

Supply voltages for such power supplies are generally 110 and 220 volts AC with a frequency of either 50 or 60 Hz. Many aircraft also have 400 Hz AC available from their engine driven alternators, but in these instances, it is usually better to power equipment from 24 volts (generally available on aircraft) than install a power supply to operate equipment off the 400 Hz AC power source.

Another consideration in selecting a power supply is how much capacitance is provided in the output of the power supply. This is important because capacitors in the output of the power supply store electricity. Acting like batteries in this case, capacitors provide instantaneous high peak output current.

**High Capacitance
power supplies
provide
instantaneous high
peak output current.**

High peak current is an important consideration if you are planning to operate in the voice mode. But if you are planning to operate in the data mode or will be using the transmitter on a more continuous basis, output capacitance is less a factor than how heavily built the transformer in the power supply is.

MOBILE POWER SUPPLIES

In virtually all mobile power supplies, the source of power is the alternator or generator system of a vehicle and the battery. You should consider several principals of good design that affect the mobile environment when operating from a mobile position on the HF bands.

First, HF requires quite a bit of power when transmitting. Although you can use a single battery to power both the vehicle and the radio, SGC recommends that you install an additional battery in all cases where this is practical. The reason for this installation is that the output voltage from a battery drops as the load increases. The more reserve current capacity, the lower the voltage drop under high intermittent power demands.

On occasion, you will find that some vehicles operate with 24 volt DC power in the mobile and marine services. Two approaches can be taken. First, you can install a 24 to 12 volt converter. This converter is usually expensive. A much less expensive approach is to look for a 24 volt system that uses two 12 volt batteries in series. If you are fortunate enough to find this type of system, simply connect the 12 volt batteries with the negative post of one battery tied to ground, the positive lug of that battery connected to the negative terminal of the second battery, and the positive lug of the second battery as the + volts terminal.

The extra battery will be of assistance when your vehicle is not running; then you will be able to operate the transceiver for a varying amount of time (depending on the power output of your transceiver and how much time you are transmitting). However, your alternator must be able to provide the power to operate everything in your vehicle. If you are transmitting continuously, the heat is being blown by the fan at full blast, and the high beams are on, you might be consuming more power than the power system is capable of producing. If this is the case, the accessories will operate from the batteries until they have drained. Then, the transceiver will operate at a lower output, the heater will produce less warm air, and the lights will probably dim. After you turn off the vehicle, you will find that it won't start because you have drained the battery.

As a result, it is important to check the current drain of the transceiver during transmitting, plus the total current drain of the other vehicle accessories. Add these figures together and see how they compare to the current output of the alternator. If the drain is anywhere above just under the output of the alternator, then you should purchase a higher powered alternator, such as those that are made for high-power car-stereo systems.

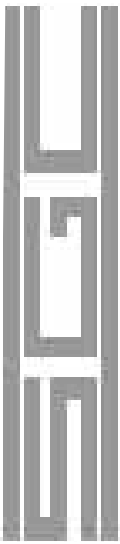

In mobile operations, the biggest problem you will run into will be noise. Although noise is often found in fixed locations, the mobile environment, including marine applications, noise sources can vary, depending on the engine speed and other variables. Noise and its removal are covered further in this user guide.

Noise is the biggest problem in mobile operations.

SOLAR-POWERED CHARGERS

Not much needs to be said about solar charging systems, except that good design practice must be followed to provide reliable operations under all conditions that you could expect to be encountered.

The most critical element when designing an HF solar power system is to know about the local weather conditions. If you are designing a solar system for an area where there will be little sunlight for many days in a row, then a large battery system and additional solar panels will be necessary. On the other hand, if you are designing the system for an area where there is a lot of sunshine at all times of the year, then you will need fewer panels. In some cases, two 53-watt panels and one good rechargeable gel cell battery will be sufficient.

Seasonality must also be considered. Obviously, in the high Arctic, solar power is ideal for the month or two during the year when the sun never goes down. But in the other months, solar power is just not feasible. Hence, another consideration should be the latitude where the solar system will be installed and a calculation of the number of hours of daylight that will be available during the shortest days of the year.

The type of regulator that is selected to control the output of the solar panel(s) is very important. It should operate over a wide range of loads and should continue to provide trickle charging to keep the battery system charged to its fullest between operating sessions.

HUMAN-POWERED CHARGERS

Human-powered chargers are only suitable for low-power transmitters that are in the 20-watt class and under, such as the SG-715 manpack. Human-powered chargers will only supply a few watts of power on a continuous basis. However, when they are used in conjunction with a battery, they provide a good means of recharging when solar panels are not practical and other sources of power are not available.

Human-powered chargers are usually in a "coffee grinder" or "ice cream crank" configuration and are used by one person at a time. They are not typically included in an HF installation. However, human-powered chargers are often used for backpack transceivers in the field or in instances where periodic access to conventional re-powering sources are not available. In amateur radio applications, modified bicycle battery chargers were a somewhat common novelty during the early years of consumer solar panels, in the mid to late 1970's.

CHAPTER 3

**HF ANTENNAS, FEEDLINES
AND GROUNDS**

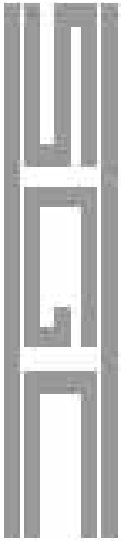

HF ANTENNAS, FEEDLINES, AND GROUNDS

The antenna is any object that receives radio signals and inputs them to a receiver or emits radio signals from a transmitter. As a result, during emergency or makeshift conditions, anything from bed springs to barbed wire fences can be used as an antenna. However, antennas are critical to good reception and transmission and the following sections show how to build suitable antennas and what types might work best for your situation.

In emergencies, anything from bed springs to wire fences can be used as an antenna.

OPERATING ENVIRONMENT

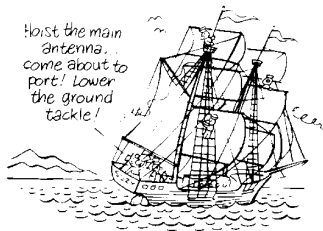

It would be reasonable to expect that HF antenna systems would all be somewhat similar. In most low-space or mobile situations, the basic HF antenna systems are unwieldy and you would not be able to install one. However, these antennas are somewhat flexible (from a theoretical and a physical point of view) and by following or altering some of the basic designs, you can create systems that will suit your needs in almost any situation. The following list shows some of the circumstances where different types of antennas are required.

BASE

Base-station operations require the most basic full-sized antennas. Because most base stations include some real estate, large wire antennas can usually be installed without problems.

MOBILE

Mobile operations require antennas that can be mounted on a moving vehicle. This rules out wire antennas. Mobile antennas are typically derivations of the whip vertical antennas, although some others have been used, depending on the vehicle used and the circumstances. SGC makes a full line of mobile high performance antennas, such as the SG-303.

MARINE

All mobile antennas can be used for marine operations, and some (not all) base antennas can be used as well. When installing an HF system on a ship, the key factor behind what antennas can be used is the size of the vessel. In some cases, a standard full-sized antenna can be used, but on small vessels, whip verticals would be a better choice. On a sailboat, the best antenna is an insulated backstay or forestay.

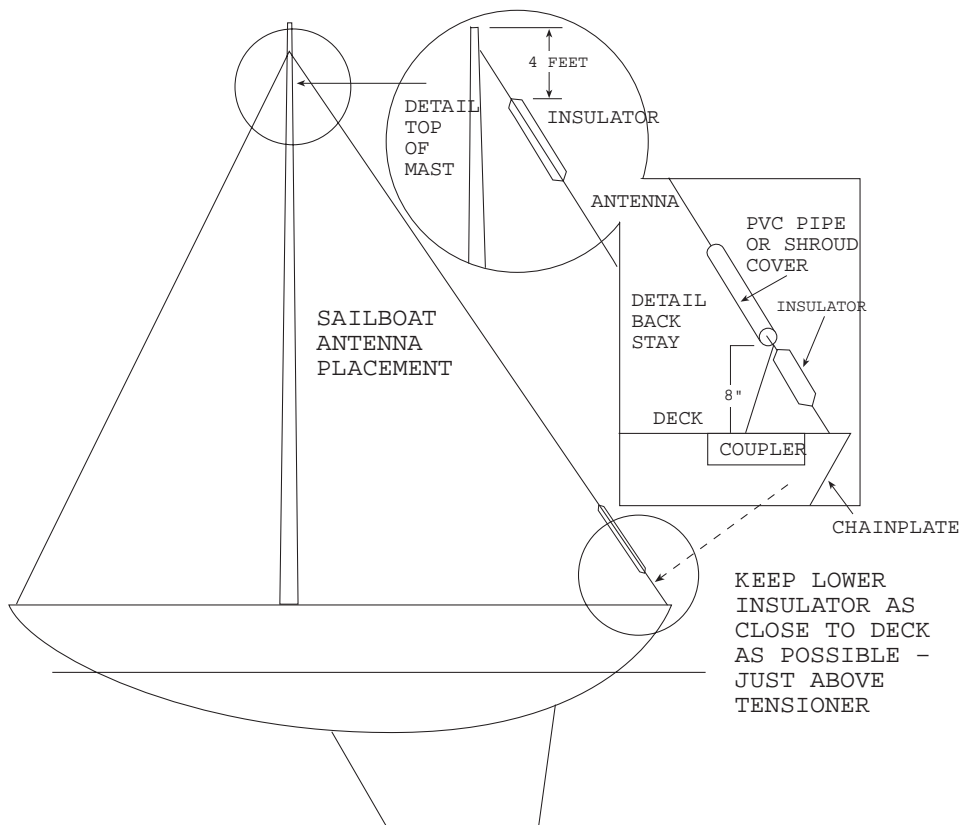

FIELD

Typically, it is more important for field antennas to be easy to install, rather than to be compact. However, everything depends on the goal of the operator, the environmental conditions of the location, and the length of time that operations will be occurring from that location.

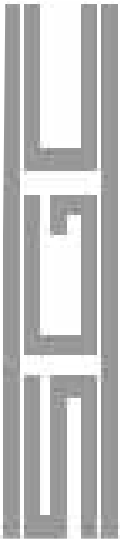

AERONAUTICAL

Aeronautical operations require antennas that are both compact and out of the way. Usually either vertical whip antennas or wire antennas that are strung along the craft are used.

ROTARY AIRCRAFT

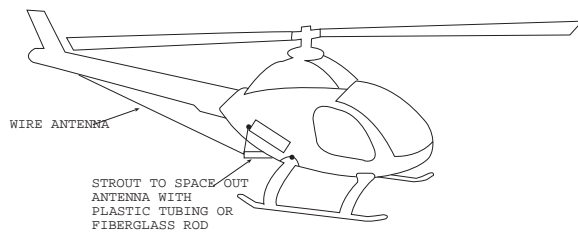

FIXED WING AIRCRAFT

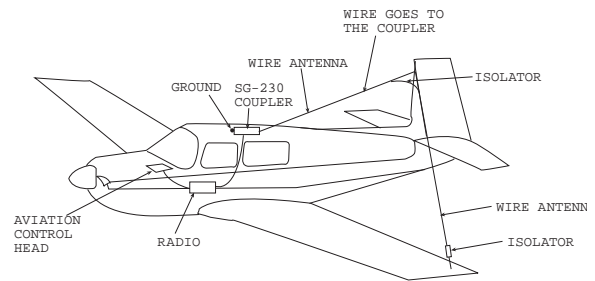

ANTENNA PATTERN BASICS

As covered much earlier in this user guide, radio signals are waves that travel through the air. Every radio frequency is at a different wavelength because the frequency is the number of waves that pass by a particular point in a second (radio waves all travel at the speed of light).

Many years ago it was discovered that in order for antenna systems to work correctly, they should be the same size as or a certain fraction of the actual wavelength of the radio signal that you are listening to or plan to transmit. This theory is known as resonance--every antenna should be cut to a resonant frequency, if possible, for best results.

The most basic type of antenna is simply a long wire, known as a longwire (brilliant deduction, eh?). It is simply a piece of wire that is strung in a relatively straight configuration and is cut to a single wavelength for a given frequency. If a transmitter was sending a signal into one end of this antenna, most of the signal would be directed off of the end of the wire (away from the transmitter). The signal pattern from the end is not like an angle

that spreads out; the pattern actually shows lobes that shoot out from along the wire (but not right off the end). If you looked at the pattern from the end of the wire, it would look something like a doughnut.

The signal emission pattern changes depending on how high above the ground it is. If the wire is placed anywhere from a 1/2 wavelength off the ground or higher, the pattern will remain almost perfect. As the wire gets closer to the ground from the 1/2 wavelength figure, the pattern becomes more skewed.

The Signal Emission Pattern changes depending upon its height above the land or sea.

Another way to change the signal pattern from the antenna is to add another wavelength to the wire, thus making it two wavelengths long. Now the lobes are tighter, more numerous, and at an angle that is even closer to that of the antenna wire.

Objects always appear different when you look at them from a different angle. So, now imagine that the original one-wavelength wire is no longer horizontal, but is now vertical, with the end at the ground being fed by the transmitter.

Angle of Radiation: the angle that radiation leaves an antenna, with the horizontal land plane as a

The pattern from the antenna is the same and the angle by which the signal leaves the antenna is the same. A figure that is related to this angle is the angle of radiation, which is the angle that radiation leaves the antenna, with the horizontal land plane (not the antenna) as the reference. The angle of radiation is important because of the bending of the signal in the atmosphere. If the angle of radiation is "low," then the signal will reach the ionosphere at a large distance from the transmitter site, the angle by which the signal is refracted will be wide, and the distance to the first hop will be equally distant. The opposite will be true of the angle of radiation is high. As a result, antennas with low angles of radiation are preferable if long distance is a must and antennas with high angles of radiation are better for short-distance communications.

As you could see from the one-wavelength horizontal longwire antenna, the signal was being emitted in a particular direction. And as the antenna grows in wavelengths, the transmission characteristics become even more directional. As a result, antennas such as the longwire are important if you are trying to communicate with station(s) from a particular direction. If you want to reach all directions equally well, then an antenna (such as a vertical) would work best. The radiation pattern from the vertical antenna (as described in the previous paragraph), is toward the sky, but from a "doughnut" pattern around the wire. This all-sides-equally-well pattern is known as being either omnidirectional or nondirectional.

Omnidirectional or Nondirectional antenna: radiates an "all-sides-equally-well, donut-shaped, pattern".

The illustrations that have been covered so far in this section only cover signal transmission patterns. However, you can expect that any good transmitting antenna will also be a solid antenna for receiving. Likewise, receiving antennas will have the same general characteristics for receiving as they would for transmitting. For example, if a directional antenna produces a particular set of lobes when transmitting, the directions that those lobes face will be where the antenna receives best from (if you aim your antenna so that you can transmit to Europe, that antenna will also be best poised to receive signals from Europe). As you can see, the receiving characteristics of antennas are so



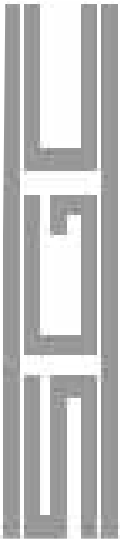

abstract that they are difficult to illustrate without showing their transmitting patterns. Just remember that although every good transmitting antenna is a good receiving antenna, not every good receiving antenna is a good transmitting antenna. And, every receiving antenna carries practically no power, while every transmitting antenna carries RF power. More on this in a following section.

Antenna Directivity: when using a directional antenna, the concentration of signal in a particular area.

If you are spreading your signal in all directions through a nondirectional antenna, then your signal would not be concentrated. However, if you use a directional antenna, then your signal is being concentrated in a particular area. This concentration is said to be the gain of the antenna. Many manufacturers use the term gain for comparative elements from one configuration or situation to another. They should be clearly understood before using comparatives in a system design or specific application.

One other important difference between the vertical wire and the horizontal wire is the polarization of the signals as they are being transmitted and received. Radio wave polarization is quite complex, but you can assume that if your transmitting antenna is horizontal, then your signal will be horizontally polarized. The same line of reasoning holds true for vertical antennas. However, propagation can alter the effects of polarization and either turn it upside down or turn it sideways so that the signal is diagonally polarized. Polarization is not of great importance, but an antenna will generally receive a bit better if it is of the same polarization as the signal that is being received.

An antenna will generally receive better if it is of the same polarization as the signal that is being received.

Thus, if several stations that you must frequently contact use vertical antennas (vertical polarization), then you might consider using a vertical antenna as well. This theory can hold its own in some cases, but different factors can overrule it. For example, if you want to contact a low-power station from the other side of the world, you would be better off having a longwire pointed right at the direction of the station than to have a vertical antenna. The positive effects of the longwire's gain would outweigh the fact that the antenna is of the opposite polarization. Also, at such a great distance, it is likely that the signal would be refracted with some parts of the signal being vertically polarized, some parts horizontally polarized, and some parts diagonally polarized. By this point, it wouldn't really matter how your antenna was polarized. As a result, the manner in which your antenna is polarized is not one of the major factors in deciding which HF antenna you should choose.

Thus far, all of the antennas have had one single element. Although there isn't enough space to cover it all here, all antennas consist of antenna elements and grounds or ground elements. The resonant antennas (those that are cut for a specific frequency) have ground elements and the nonresonant antennas require an excellent ground system

Resonant or non-resonant antennas require a ground system.

(covered in a further section) to perform well. The two antennas covered in this section (the horizontal wire and the vertical wire) could be made as a balanced antenna if a half-wavelength of wire was cut in half; one section would be connected to ground and the other half to the "hot" transceiver lead. Or the antennas could be left as unbalanced antennas. In this case, the ground lead from the transceiver would be connected to an excellent ground.

ANTENNA CONSTRUCTION BASICS

Although some of the basics of antenna construction and materials are covered here, this is not meant to be a definitive course on building your own antennas. Many books have been written about antenna construction and you could easily fill a few volumes on the subject. Instead, this section is mostly just intended to help you to choose the type of antenna that would best work in your situation, and how that antenna should be constructed. For further information on basic receiving antenna construction, see *Build Your Own Shortwave Antennas (2nd Edition)* by Andrew Yoder from TAB/McGraw-Hill. Note, however, that this reference is not intended for transmitting antennas.

Most typical HF antennas are large (or at least long) because of the very long wavelengths of these signals. For example, a full wavelength at 30000 kHz is 30 feet 14 inches and a full wavelength at 1700 kHz is a whopping 550 feet 8 inches! Because of the lack of space for such large antennas, most are designed to be either a half or a quarter wavelength. Because of the large size and the low power levels involved (usually under 1000 watts for most HF installations), most HF antennas (except for the mobile whips and the rotatable antennas) are constructed out of wire.

Different types of wire can be used for HF antennas, but generally stranded copper wire is the best. Copper is the best low-cost conductor (don't even think about using stranded silver, platinum, or gold!), so it allows more of your signal to pass from the conductor to the air. Also, it is strong, won't easily stretch (unlike aluminum wire), and won't quickly corrode away (unlike steel or iron). Stranded, rather than solid, wire is the best because the wires will probably be bending and swaying in the breeze for most of their time in the air. As a result, an antenna made from solid copper wire will break much quicker than one made from stranded copper wire.

The gauge of the wire is a factor that is important when constructing a transmitting antenna, but not a receiving antenna. The importance of the wire gauge relates to a principle known as skin effect. Skin effect is an interesting principle, whereby all of the signal from the transmitter is concentrated on the outside ("skin") of the wire. Beyond a certain breakdown surface area-to-signal ratio, the wire will begin to heat up. In one instance, a broadcast engineer was using over 1000 watts into a small-gauge dipole antenna. The wire gauge was too small to support the output power, and the wire heated up. After a few minutes of transmitting, the antenna wire burned up and the remains of the dipole fell to the ground! For best results with powers under 1000 watts, you should use any of the following wire gauges: #6, #8, #10, or #12.

The Bandwidth is the frequency range within which the antenna can be used for transmitting.

The gauge of the wire also has an impact on the usable bandwidth of the antenna. The bandwidth is the frequency range within which the antenna can be used for transmitting (without any matching devices) or most effectively used for receiving. The bandwidth depends on the type of antenna that is used, the gauge of the wire, and several other factors. A typical antenna for base operation can be used for approximately 200 to 300 kHz above and below the frequency that it is cut for. The problems of having your antenna out of resonance are that it causes high SWR, which is covered further in one of the following sections.

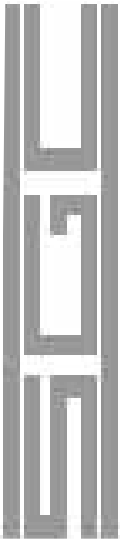

Sometimes people become confused about skin effect or hear some tall tales of antenna design. Skin effect is the subject of many tales. One of the best stories involves the tarnish on non-insulated copper wire. A radio hobbyist insisted on non-insulated wire (because the insulation would prevent the signal from leaving wire as easily) and he would even pull down his wire and sand the tarnish off every spring (for the same reason)! Tarnish and insulation on an antenna conductor will not hinder its performance. In fact, most people prefer insulated wire better because they frequently move and replace antennas. The insulated wire slides through trees better and you're not as likely to cut your hand on a broken strand. Also, insulation protects anything from being burned by the signal that is being transmitted through the antenna. There's nothing like bumping into a "hot" antenna and getting a nice RF burn across an arm or leg.

ANTENNA TYPES

Over the century since radio has been discovered, hundreds (if not thousands) of antennas have been used with varying degrees of success. The antennas included in this section are some of the most popular. Some of these antennas are merely variations on another type. Others are variations, but are used in such peculiar circumstances that they are always considered to be separate types of antennas. Regardless of the style, the shape, or the construction of the antennas, the wavelength for radio frequencies is always determined with the same equation:

$$l \text{ (length in feet)} = \frac{936}{f \text{ (frequency in MHz)}}$$

However, you will notice that most antennas are half-wave or quarter-wavelength. For these antennas, the length is exactly 1/2 of the length that you would determine from the equation above. Even if you are not planning to build your own antenna system, the equations and specifications included here will help you to determine the length and determine whether you have the space available to install one or more.

LONGWIRES AND RANDOM-LENGTH WIRES

The longwire was used as an example for the beginning of the antenna section. The standard longwire is an unbalanced antenna that is several wavelengths long for the frequency that it is to be used at. Longwires are typically used because of their excellent directional properties. Dedicated amateur radio operators and professional monitoring posts often install an array of these antennas in a half circle, with the ends all pointing in different directions. However, few people have the land to install antennas that cover several thousand feet in all directions.

**Longwire antennas
have excellent
directional properties.**

The longwire (or arrays of longwires) is used by serious radio users with a big commitment to radio and its operations. The random-length wire is the opposite; it's a relatively short wire that is used when you just don't have the space or money to install a better antenna. Unlike the longwire, the random-length wire is often much less than a wavelength for the frequency at which it is to be used. These antennas are also not as effective as others and they require an antenna matching or tuning device for proper use. However, HF communications are most important for portable, mobile, and emergency situations. At these times, you can effectively use a random-length wire antenna with an SG-230 Smartuner™ for short- or long-distance communications.

VEES AND RHOMBICS

These two antenna types are the complicated big brothers to longwire antennas. The vee antenna consists of two longwires that are separated by an angle of approximately 45 degrees. These two wires are connected to the transceiver via ladder line (covered in the section on feedlines). When a single frequency is used, use a coupler (such as the SG-230) in the center of the antenna and fed by a 50 ohm cable. Vees are very directional and are typically only used in situations where this focused antenna power is necessary.

The rhombic is basically two vee antennas connected together at the tips of the widest points to form a diamond. Instead of having another section of ladder line at the far tip of the antenna, a resistor connects the two end elements and runs to ground. Rhombics require so much land and are so directional that they are rarely used, except by shortwave broadcast stations that need to beam their signal to certain parts of the world.

The Marconi family of antennas are some of the oldest types in existence. These antennas were developed by Guglielmo Marconi near the turn of the 20th century during his extensive radio experiments. The Marconi antenna family contains any antenna that has a "hot" quarter-wave element and the other side of the transceiver is connected to ground. The most common Marconi antenna is the quarter-wave vertical (see the next entry), but one of the old classics from the 1930's is the inverted L. With the inverted L, the first 1/8 wavelength of the wire element is vertical and the other 1/8 wavelength is horizontal. Because of its bent element, the antenna radiates both vertically and horizontally polarized waves. These days, the inverted L has mostly been forgotten, but is one of the most efficient and highly recommended by SGC.



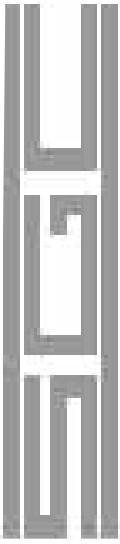

THE QUARTER-WAVE VERTICAL

This antenna is commonly used by CB'ers, public service radio operations, AM broadcast stations, and others. Typically, the quarter-wave vertical has one vertical element (the "hot" or radiating element) and the ground side is connected to a system of ground radials. Although this antenna has been criticized as "radiating poorly in all directions," the key to a good quarter-wave vertical is an excellent ground system. For the high-frequency versions of this antenna, a counterpoise ground is used. The counterpoise is a mock ground, where the ground radials are located in the air with the antenna, instead of being buried in the ground. This system is best because the antenna can be placed on a mast high above the ground, however, it just isn't feasible for frequencies below about 21 MHz.

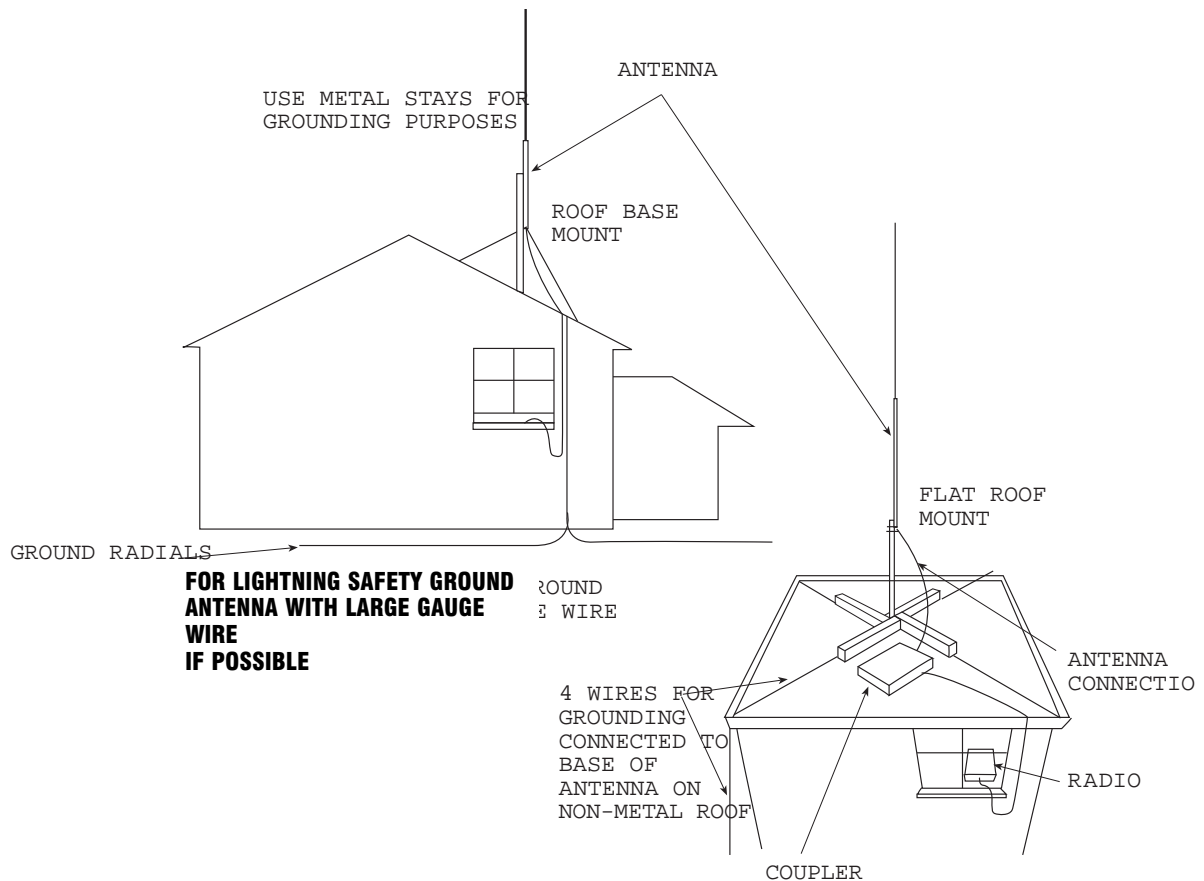

THE VERTICAL WHIP

The whip antenna is a space-saving version of the quarter-wave vertical. To save space, the wire antenna element is usually wound around a fiberglass whip and loading coils are added to make the transceiver "think" that a full-sized antenna is at the other end. Overall, the system works and it is quite possible to have regular communications from a vehicle with a whip antenna. However, the whip is certainly not the best antenna that could be used in an open, fixed location. In this case, the whip would be one of the poorest choices.

THE WINDOM ANTENNA

The Windom antenna is another form of the Marconi antenna. Standard, unmodified Windoms are peculiar relics from the pre-World War II days of radio. Rather than being fed with feedline, Windoms are fed by the "hot" output of the transmitter with a single wire; the other side must be fed to an excellent ground. The feeder or coupler (i.e. SG-230) is connected to an off-center point (usually 36% of the way across) a quarter-wave element. Like all Marconi antennas, the Windom must have an excellent ground in order to work properly. The Windom has been occasionally revamped and altered over the years; they are not covered here because most are complicated and some of these varieties have been modified to the point that they are no longer even true Marconi antennas.

THE DIPOLE AND ITS VARIATIONS

The dipole is one of the most basic and popular antennas ever for HF applications (especially for frequencies below 10 MHz). This balanced antenna consists of two quarterwave pieces of wire that are fed in the center by a piece of coaxial cable to the transceiver. The most common configuration for the dipole is horizontally. In this manner, it radiates best in two approximate directions, though it is not considered to be a directional antenna. However, the dipole can be turned on its end and be

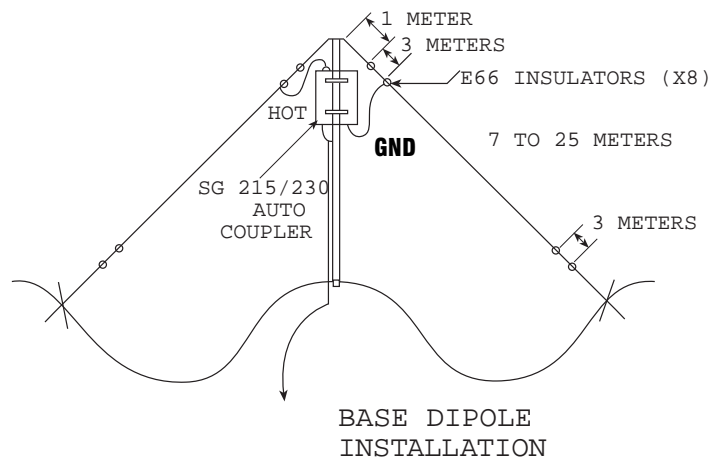

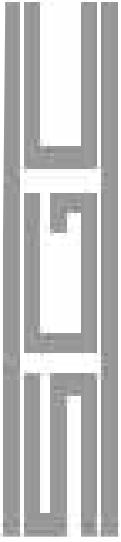

used as a vertical. The vertical dipole is more unwieldy than the quarterwave vertical, so it is less popular. Each end of the dipole can be dropped to form an inverted vee (the angle between the inverted vee should be about 120 degrees). The inverted vee has a slightly different radiation pattern than the standard dipole, but it is usually used because only one support in the middle (not three) is required to keep it in the air. The last standard variation of the dipole is the sloper. The sloper is a dipole that extends from one support in the air to the ground at about a 45 degree angle. Four slopers are sometimes placed around each direction of a flag pole or other support to form a small-space directional antenna array.

BEAM AND YAGI ANTENNAS

The building block of the beam and the Yagi antenna is the horizontal dipole. The theory behind these antennas are that if you place another similar antenna element a certain distance away and parallel to that element, the antenna will become more directional. Typically, one slightly smaller element is placed 0.25 of a wavelength to the one side of the dipole, and one slightly larger element is placed 0.25 of a wavelength to the other side of the dipole. The two elements are both called parasitic elements because they only guide the signal to the "real" antenna. The smallest element is the director, the center is the driven element, and the largest is the reflector. This three-element beam or Yagi antenna is usually made from aluminum tubing and is then typically placed on a rotor so that it can be turned. These antennas are some of the best rotatable directional antennas that are available, so they are excellent for limited-space applications if frequencies above 14 MHz are used (below this range, the long elements become unwieldy).

LOG-PERIODIC ANTENNA

The log-periodic is another derivative of the standard horizontal dipole. Instead of having director and reflector elements, the log-periodic antenna has a number of elements that are all interconnected. These elements vary in size from the front element (smallest) to the rear element (largest). Thus, nearly every element in the array works as a director, driver, and reflector at the same time. The number of elements in log-periodic antennas vary, although they can often contain as many as 12 or 15 elements. Because of the large number of tuned elements, log-periodic antennas are very directional. These antennas are very big, so they are generally used in fixed locations by broadcast and government stations that must beam a signal to a particular part of the world.

LOOP ANTENNAS

Most of the antennas described to this point have been some derivative of the dipole, longwire, or quarter-wave vertical. The loop antenna is a different type of antenna that has its own family. Typically people think of loop antennas as being small square boxes with several turns of wire wrapped around the outside. This type is somewhat common, but the most common type is the loopstick antenna, where space is conserved by wrapping wire around a pen-shaped piece of ferrite. Loopstick antennas are used in nearly every AM broadcast radio receiver on the market. Although these two types of loop antennas are poor for transmitting into, they are excellent for receiving. On the downside, loop antennas provide very weak signals to the receiver, so a preamplifier is required to boost the signal to the receiver. The best aspect of loop antennas is that they are extremely directional when small, and they can be small enough to easily rotate by hand. When large, these antennas are less directional. These two forms of loop antennas are used by hard core AM broadcast listeners and by people who need to direction-find transmitters (radio enforcement, etc.).

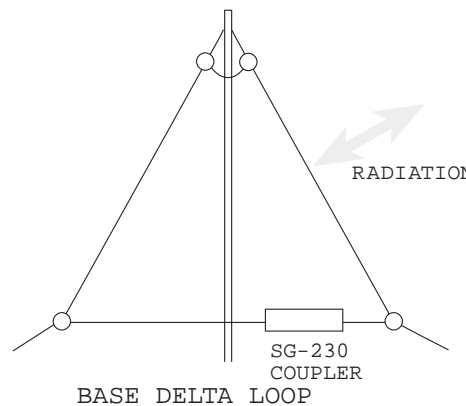

BOXES AND DELTAS

Boxes and deltas are both forms of the loop antenna. Like the other loop antennas, the "hot" side of the output from the transmitter is connected to one side of the loop and the "ground" side is connected to the other side of the loop. Unlike the previous loops, only one loop of wire is used and these are excellent for use when transmitting.

The only difference between the box and the delta antenna is that the box is a four-sided loop and the delta is a three-sided loop (likewise, the antenna patterns differ a bit). These two antennas are somewhat directional and they are excellent for use in small-space locations, where several trees and a length of about 20 to 40 feet are available, but not much else.

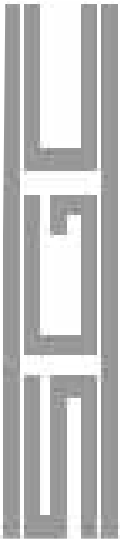

QUADS

To imagine a cubical quad antenna, think of how a dipole relates to a beam. The typical quad features three loop antennas on a crossbar. Like the beam, one of the loop elements is slightly smaller (the director), one is larger (the reflector), and the one in the middle is the active element (the driver) that is connected to the transceiver. The quad was developed by a broadcast station in Ecuador in the 1930's. The thin Andes air was causing the voltages to arc off of the ends of the station's beam antenna. To prevent the arc-over, the station engineer made the elements into loops so that the signal couldn't arc-over. Quads and beams are quite similar, but each type has a group of followers.

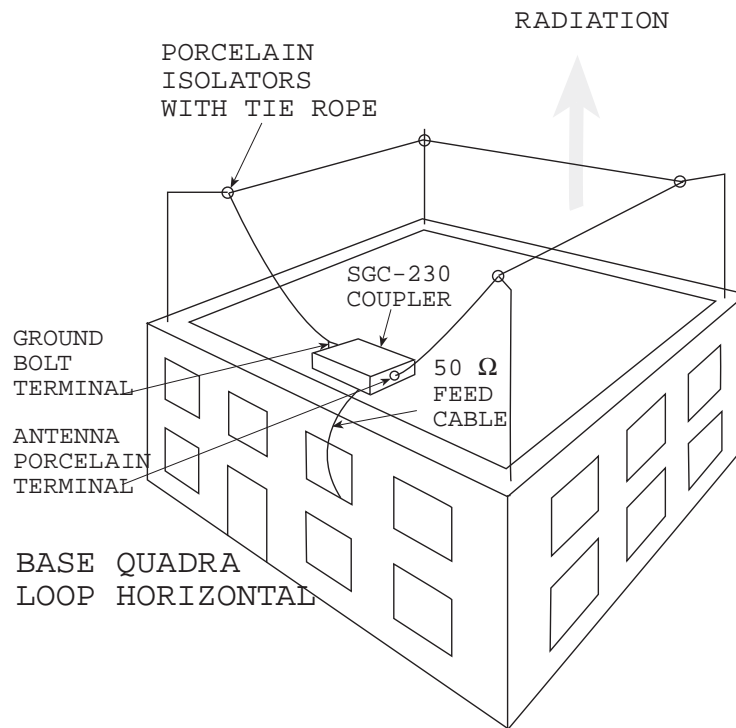

MOBILE ANTENNA VARIATIONS

A few of the antennas that are listed in this section can be used for mobile installations in vehicles, aircraft, and boats. The most popular mobile antenna, the vertical whip, was already listed. However, several unconventional types of antennas can be designed or modified for these installations. With the SG-230 Smartuner™, different random-wire antennas can be run along the top of a large vehicle, such as a van or truck, or from one part of an airplane to another. In the case of the random wire on a vehicle, the wire would have to be held above the metal roof with stand-off insulators. As an example of operator creativity, I even heard of one case, where a tractor-trailer operator installed a dipole on stand-off insulators above the trailer. Marine vessels are often ideally suited for

installing HF antennas. Of course, whip antennas can be installed on the higher parts of the boat, and because the vertical height of the boat is of little importance, you can install much larger vertical antennas than would be possible on a vehicle. Also, the natural contours of most boats make random longwire antennas a possible choice.

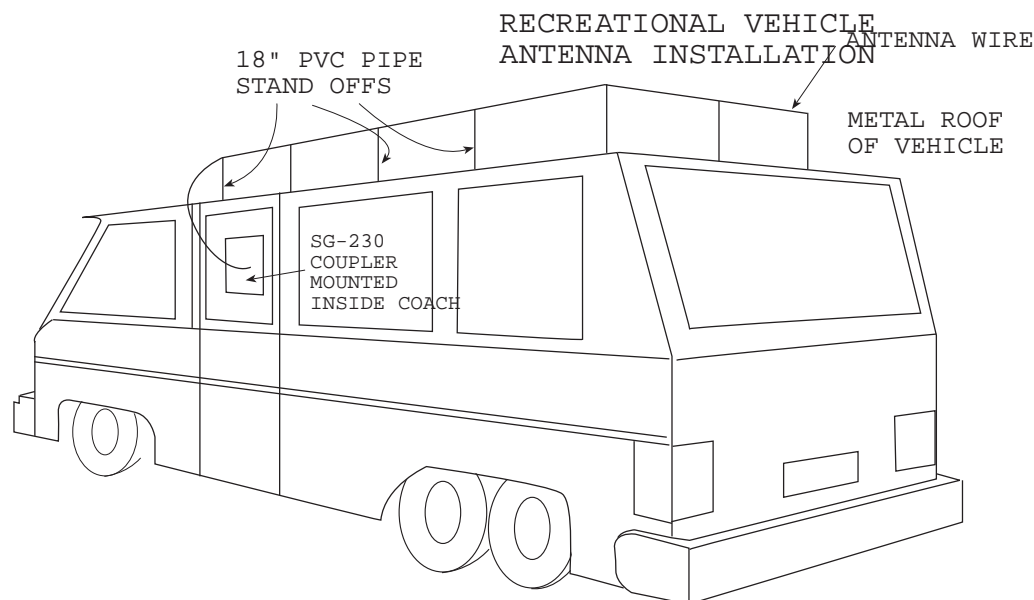

USE A SEPARATE GROUND STRAP OR WIRE FOR THE BODY AND THE CHASSIS TO THE GROUND OF THE COUPLER

FEEDLINES

Feedlines (sometimes also known as transmission lines) are the cables that carry radio signals from the transmitter to the antenna or from the antenna to the receiver. Feedlines are very important for transmitting because a "lossy" feedline could allow most of your signal to "drain" away or cause technical problems that could reduce the transmitter output portion of your transceiver.

Impedance must be "matched" in an HF system for proper operation.

Not only must these feedlines carry your signals back and forth between the antenna and the transceiver, but they must create a match between the antenna and the transceiver. What must be matched is the impedance of any given system. The impedance is the

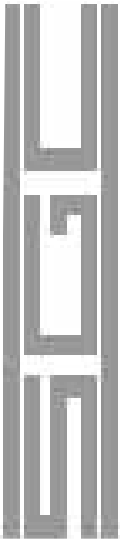

opposition to a signal flow through a component or a line. Overall, the theory of impedance in radio systems is beyond the scope of this user guide. All you need to know is that the transceiver output, the feedline, and the antenna all have their own characteristic impedances, and for proper transfer of power, should all be the same.

The problem with these characteristics is that they must all match. If they aren't at least close in value, a mismatch will occur. For example, if the transmitter and the feedline are both 50 ohms and the antenna is 100 ohms, a portion of the power coming from the transmitter, which should be radiated by the antenna, will be "reflected" back toward the transmitter. This radiation, which is developing on the feedline, is known as standing waves. The ratio of the peak voltage going to the antenna and the measured peak voltage reflected back to the transmitter is called the standing wave ratio (SWR).

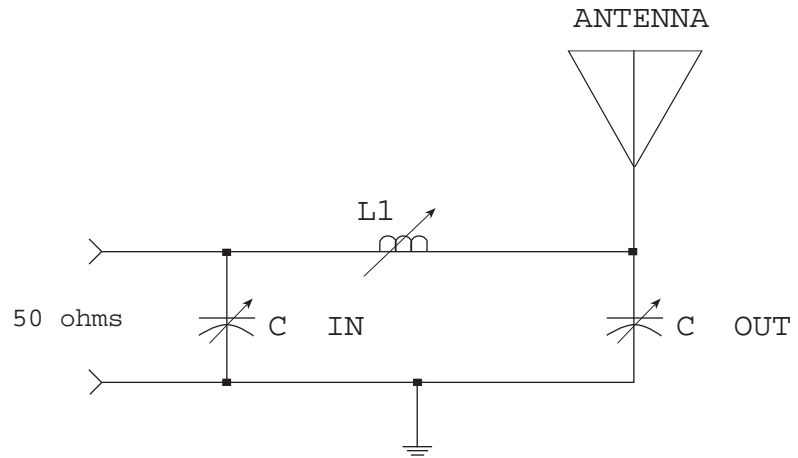

When the SWR exceeds about 2:1, the HF transmitter will reduce power to reduce the stress on the components. Reflected power has nowhere to go, so it is turned into heat. This heat can be dissipated by the feedline or it can be dissipated by the components in the output circuit of the transmitter. Either way, one of the rules of HF equipment is "heat is bad!" When older transceivers and transmitters were under high SWR conditions, they would continue operating at the same power level and gradually (or not so gradually!) damage or destroy the final output tubes.

Standing Wave Ratio (SWR): the ratio of the peak voltage going to the antenna and the measured peak voltage reflected back to the transmitter.

You could change the characteristic impedance of the transceiver to match the antenna, but you would have to tear apart the final stages of the transmitter. Modern transceivers have a connector that is meant to connect coaxial cable feedline. Coaxial cable has a center conductor that is surrounded by an insulating dielectric material. That material is surrounded by a grounded copper braid, which is wrapped in an outer insulating sleeve. The output of modern transceivers is rated at 50 to 75 ohms.

The easiest method to get a matching impedance on the feedline is simply to use a type of coaxial cable that has an impedance of from 50 to 75 ohms. Some of the most frequently used types of coaxial cable for HF use are RG-8, RG-8X, and RG-58. The last ways to get the impedance to match up properly are to use an antenna with a characteristic impedance of 50 to 75 ohms and make sure that the antenna is cut to the frequency of operations. The most

To obtain a matching impedance on the feedline, use coaxial cable with an impedance of 50 to 75 ohms.

common antennas that can be fed with coaxial cable (and not require any matching devices) are those in the dipole family.

With coaxial cable, the grounded shield prevents interference from entering the "hot" center conductor and it keeps the transmitted signal from leaking out through the line before it can be radiated by the antenna. Coaxial cable is an unbalanced line; the signals traveling down each side are not the same.

The antennas in the longwire group (for example) all require either twin lead, open wire, or ladder line feedline. These types of feedlines are all types of balanced lines. Balanced lines are merely two (or sometimes four) parallel conductors that are separated by a particular distance (usually anywhere from one inch to a few inches). Balanced lines don't have any shielding because they don't need any; having the same signal running down each line keeps the lines balanced and prevents them from radiating the signal. No transceivers have outputs for balanced lines; if you want to use this type of transmission line, the most common solution is to run a short piece of coaxial cable to an SG-230 Smartuner™, which will solve the problem.

Another solution is to use a balun in line with the antenna. A balun is a contraction of balanced-unbalanced. The system features a transformer that matches the impedance of the 50-ohm output of the transceiver to the 300 or 600 ohm antenna, depending on the value of the balun that you choose. Most commercial baluns are small cans that screw into the coaxial cable at the connection between the antenna elements. Not only do these baluns improve performance, but they are constructed so that it is easier to build the antennas.

The most important characteristic to look for when purchasing balanced feedline (or an antenna that uses unbalanced feedline) is strength and flexibility. If it looks like it will last in the elements, use it. Coaxial cable is a much trickier purchase. Every component within the cable is essential to good operation. First, the center conductor should be of a heavy enough gauge to handle transmitting powers (usually about #16 or thicker). Next, you should make sure that the insulating dielectric is strong and won't break down in the presence of heat or water. The most important option is to make sure that the shield is made from a solid copper braid that covers 95% (or better) of the cable. Without this high-percentage, low-loss braid, some of your power will drain out through the coaxial cable. The last part of the cable is the outer sleeve, which must be strong, flexible, heat-resistant, and resistant to ultraviolet rays. In this era of increased environmental awareness, coaxial cable is one product that can't be biodegradable! The safest way to choose good-quality coaxial cable is to pick a type that is made according to industrial or military specifications.



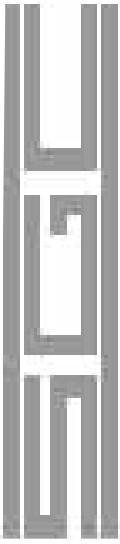

GROUNDING SYSTEMS

When working with HF transceiving systems, it is very important to have two types of grounds. The first type of ground is simply referred to as a ground or as an equipment ground. This type of ground is very important to reduce external interference in your system and prevent nasty electrical shocks if a piece of your equipment should happen to fail and make the chassis, knobs, or switches "hot." The other type of ground is the RF ground, which is necessary to obtain good performance while transmitting.

EQUIPMENT GROUNDS

An equipment ground is only essential to avoid electrical shock from the main AC line. Since most equipment is operated from 12 volts DC, it is important to have the DC power supply grounded properly to the AC neutral ground. Grounding the radio transceiver to a nearby metallic structure is not always recommended, because that structure or ground may be polluted with appliance or RF industrial noise. Making this connection may significantly increase the noise level captured by the receiver. Make the final connection only after testing your system for proper operation and only then, if necessary.

RF GROUNDS, COUNTERPOISES, AND GROUND PLANES

As was stated earlier, RF grounds are necessary for an effective transmitting system when using Marconi antennas with balanced feedlines. Unlike some other less-tangible radio theories, the physical laws behind why grounds improve transmission efficiency are easy to understand because it is exactly the other half of your transmitting line system. For example, if you need to supply power to your car headlight from the battery you need a positive wire (your antenna) and a negative wire to return to the battery (your RF ground). It is that simple because one will not work without the other.

RF grounds differ both in function and design from standard equipment grounds. The most important concept is that RF grounds can be tuned to resonance at a major frequency of operation (just like antennas) to be effective. To be on the safe side, a groundwire has to be at least the same length and diameter as the antenna (refer to a dipole antenna). However, it is recommended to use several lengths of wires of a size not less than the antenna to make your own ground system. The great advantage to making your own ground system is that you know exactly what is there and generally you can isolate it from any polluted appliance or industrial grounds.

BASE STATION GROUNDS

A superior Base Station equipment ground consists of 12 or more Radials.

The grounds for base station operations generally require the most work, but they are also the most effective. The best ground starts with wire radials longer than the antenna and at least the same size or larger in diameter than the antenna wire. Make sure that the wires have both a solid physical and electrical connection. For best results, 12 or more of these wires should be spaced evenly as they radiate out from the center pipe. As a result of this pattern, the ground wires are typically called radials. There is no real limit to the number of radials that can be buried; some amateur radio operators who use the 160-meter band (approximately 1850 kHz, where a quarterwave radial would be 126.5 feet) literally have several miles of ground wire buried in their yards.

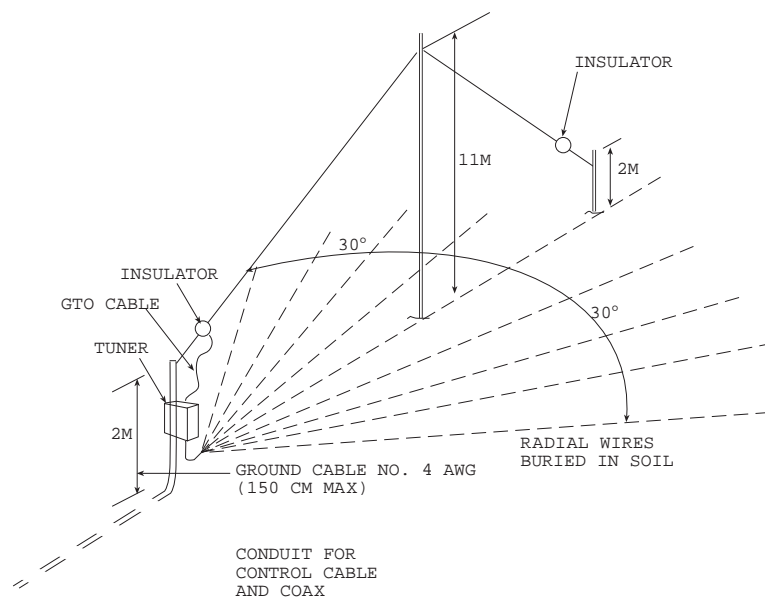

BASE INSTALLATION WITH GROUND WIRE RADIALS

The wires should then be buried several inches in the ground. The depth of the radials makes no difference in the performance of the ground; the most important thing is that they are making good contact with the ground and that they are buried deep enough to prevent people from tripping on them (and possibly hurting themselves or damaging the ground in the process).

To maximize the ground's performance, and especially for ground wave, it is best to have high ground conductivity. Ground conductivity is simply the measure of how electrically conductive your soil is. Water and metals are all very conductive and salt improves conductivity. As a result, the best location (as far as a ground is

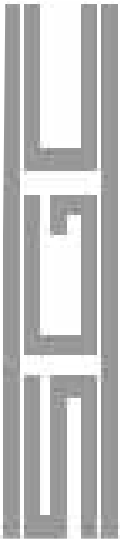

concerned) that you can operate from is a salt marsh. Salt marshes aren't overly abundant, so other methods are used to improve the conductivity of the soil and the performance of the ground. One method is to remove several inches of soil for the entire circular area where the ground radials are to be set. Then wire mesh is unrolled over the area. Afterwards, the ground radials are installed and the dirt or sod is laid overtop. This system improves the

High Ground Conductivity maximizes a ground's performance.

conductivity considerably. Another method is to spread rock salt in the ground around the radials and the center pipe. The problem here is that the salt will corrode the ground system quicker than if it was buried in relatively salt-free soil.

FIELD-OPERATION GROUNDS

If you are out in the field for an extended period of time, you will need to communicate with other stations and some sort of ground system will probably be necessary. However, the time and cost involved to install a large grounding system just isn't practical. This is where the counterpoise or a ground radial wire set is handy. As stated previously, a counterpoise is an artificial ground. One of the most common types of counterpoises is basically the same as the buried ground radial system that was described in the previous paragraph. This system, however, is staked above the ground level and it consists of approximately 8 ground radials. Either wooden or metal stakes can be used, and they should hold the ground system at anywhere from one foot to several feet off of the ground level. If you take some care with winding the radials up after each use, you should be able to install and remove one of these counterpoise ground systems in between 30 and 45 minutes

A Counterpoise--an artificial ground--is preferred for most operations.

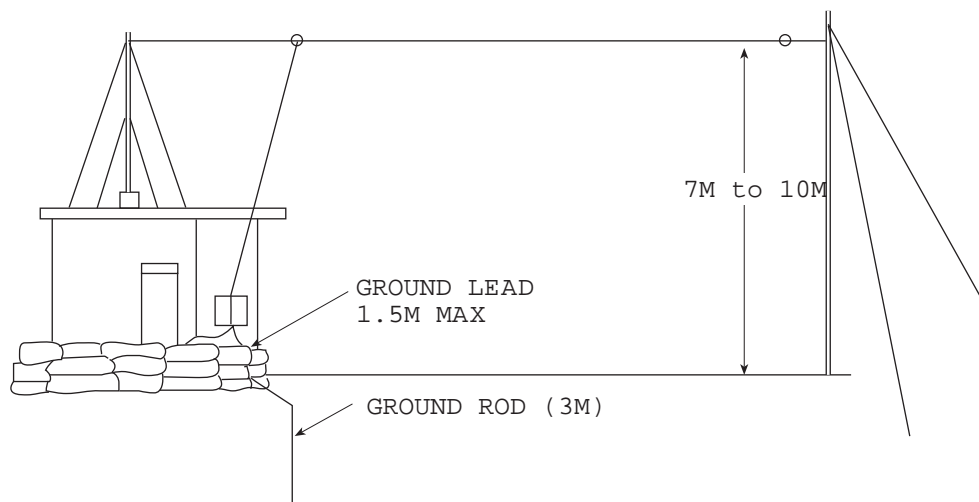

BASE INSTALLATION

MOBILE GROUNDS

The best vehicle ground is to attach the ground strap to the chassis.

Mobile grounds are particularly critical because it is difficult to install a system on such a small area that is moving. Even though vehicles are constructed from steel, the amounts of metal per car are decreasing each year, as plastics are used more. Even though large amounts of metal are still used in vehicles, some metal parts are isolated (insulated) by plastic or paint. As a result, even if you attach the ground cable to bare metal on the vehicle, you are not guaranteed of a solid mobile ground. Your best bet is to attach the ground strap to the chassis and make sure that they are making a good electrical connection. To do this, clean the metal with a wire brush, then fasten the ground with a self-tapping sheet-metal screw. After you have finished tightening the screw, spray the connection with a light coat of weather-proof spray paint to protect the connection from corrosion.

To further improve the ground mass, ground the doors, hood, and trunk lid to the vehicle's chassis using a #0 (or larger) ground braid. Another improvement is to check the exhaust pipe and ground it properly. These tasks will all improve the ground (and improve the efficiency of your transmissions) and reduce the possibilities of interference while receiving.

If you typically operate the vehicle for several hours from a parked location, a quick counterpoise ground might be a convenient solution. In this case, you would have 4 or so ground radials installed on the back of the vehicle. Whenever you reached a parked location for transceiving, you could unroll the wires and hold them with stakes. This wouldn't be an ideal counterpoise ground, but it would be a decent system for semi-mobile operations. By the same token, you may attach a longwire to your existing mobile antenna.

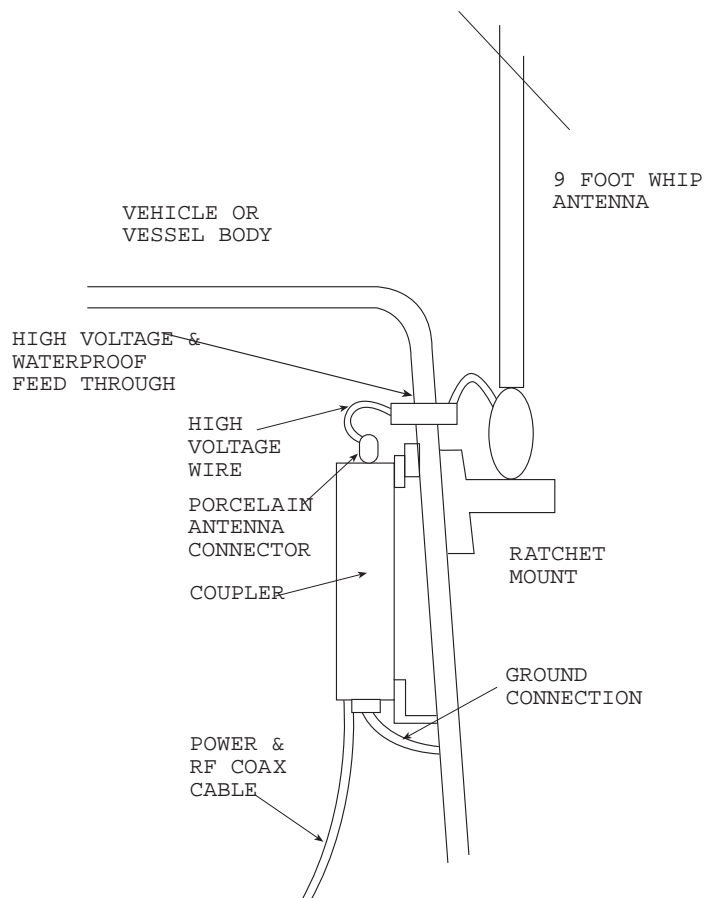

SAILBOAT AND POWERBOAT GROUNDS

Bonding is the process of tying all vessel metal into a single electrical point.

Bonding, as it is called in marine circles, is the process of tying all vessel metal into a single electrical point. The reason for this bonding is that for an HF antenna to radiate properly, a larger ground system than the antenna must be present. This installation is not difficult, but you must be willing to invest some time. The recommended bonding material is copper foil or wire, which is available in several different widths. However, you should always route the foil in such a way that you can keep all leads direct. Other materials are sometimes used for the boat grounding, but these are subject to corrosion and marine growth. There is no substitute for lots of copper (except lots of silver, platinum, and gold)!

HULL (TOP VIEW) SHOWING ROUTING OF 2" ~ 3" COPPER BONDING

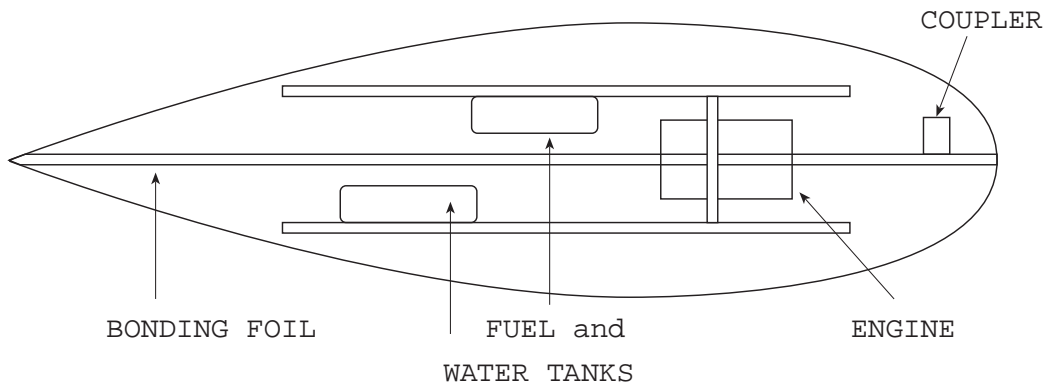

If your boat has a fiberglass hull, line the inside surface of the hull with a large area of copper foil. If the foil is separated from the sea by 1/2 inch or less, the copper will form a capacitance bond with the water and work as a very effective ground. If the hull is made from aluminum or another type of metal, you are almost guaranteed of an excellent ground - especially if the boat is sailing in salt water. Just attach the ground strap or a piece of copper foil (that is at least several inches wide) from the transceiver to the hull.

Bonding foil should be routed to keep all leads direct, in a straight line.

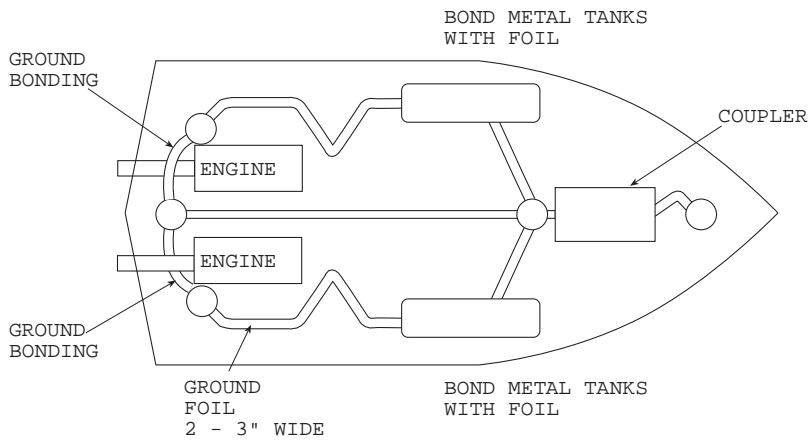

FIBERGLASS HULL SPEEDBOAT

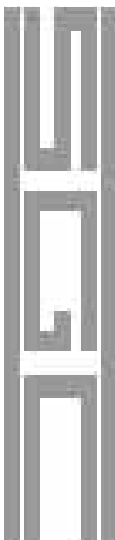
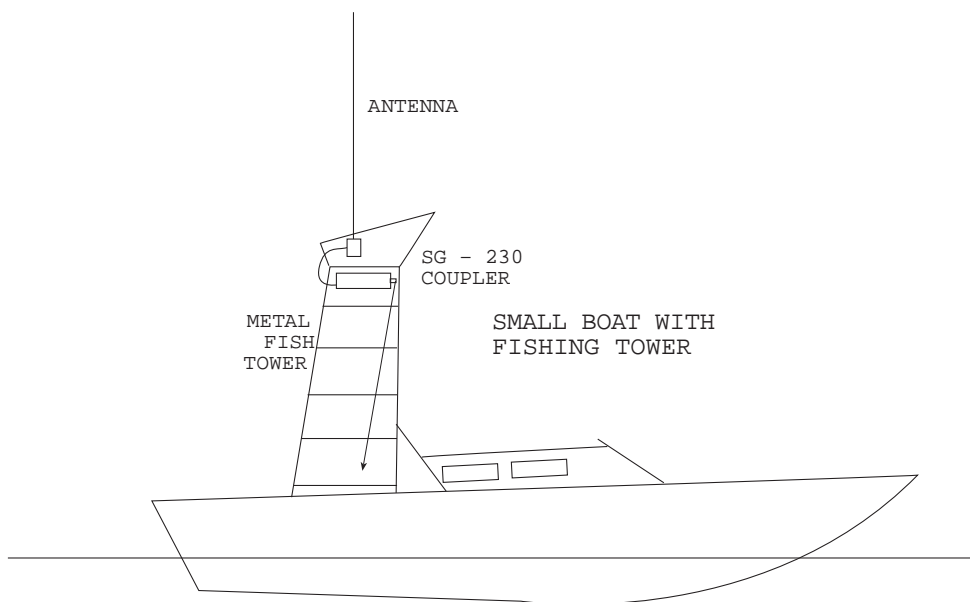
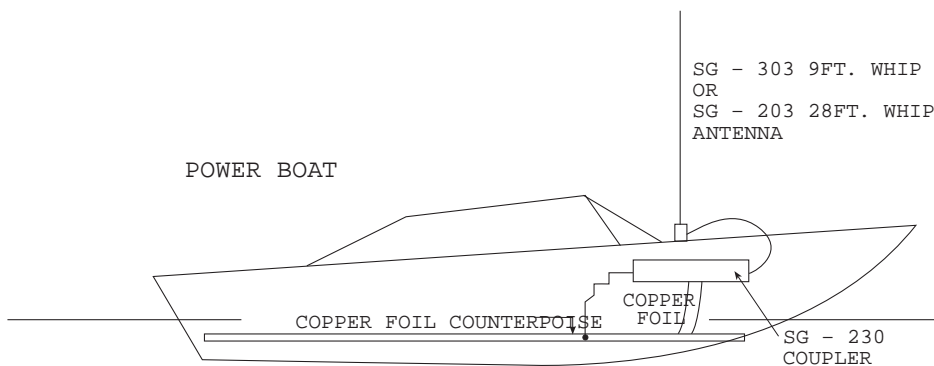

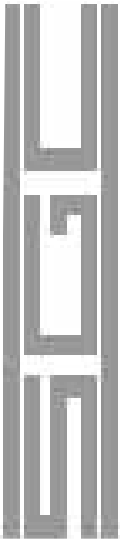

AIRCRAFT GROUNDS

Like boats, aircraft fuselages are covered in various materials, conductive or nonconductive. As a result, you will need to choose your ground location carefully. If the skeleton of the plane is aluminum and seems to be electrically bonded throughout, attach the ground strap to the aluminum. As in any mobile radio installation, be sure to wire brush the surface of the metal before attaching the ground strap. Likewise, after you have attached the ground strap, spray a light coat of weather-resistant spray paint over the area.

GROUND DAMAGE, AGEING AND MAINTENANCE

Even if your ground connections are not in a location where they are in extreme weather, they should be checked occasionally. All mechanical joints should be very tight or they will corrode under the presence of oxygen and moisture. This light tarnish or rust will isolate the connection from the ground and ruin the system. In addition to covering joints with a light coat of spray paint, it's a good idea to entirely encase the joint in a few globs of silicone bathtub caulking that you can apply with your finger. For long, thin connections, such as wires, wrap the connections very tightly with electrical tape, then cover the electrical tape with a light coating of silicone bathtub caulking.

Ground systems which corrode due to natural age may be repaired on a periodic basis. Outdoor conditions can be destructive to ground connections, but the worst-case scenario is on marine vessels in salt water. As a result, you should check out the connections every six months and if you have any question about their integrity, scrape off the caulking, unscrew the bolt, wire brush the metal, and do it all over again.

Periodically check ground connections for corrosion or aging.

Another problem with marine grounds (especially) is electrolysis. In this type of electrolysis, electricity is flowing through a metal conductor and the water surrounding the conductor breaks down into oxygen and hydrogen. As this process is occurring, the metals are also slowly being eaten away. As a result, you should check the metals in the grounds to make sure that everything is working properly.

The radial ground systems at base stations are perhaps the most difficult systems to keep up regular maintenance on. Fortunately, base station grounds will usually last for a number of years--perhaps several decades. Even so, you should regularly check the connection at the base of the radial system (where all of the radials connect to the copper ground pipe). If this connection goes, all of those buried ground radials are virtually useless.

CHAPTER 4

INSTALLATION

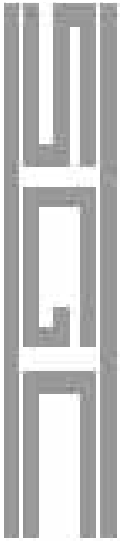

INSTALLATION

The installation of any radio shack or portable system is of utmost importance. Of course, everything seems as though it's of utmost importance with HF radio systems! In all of the other cases, it's been for technical or practical reasons that something was done in a particular manner. In the case of setting up the shack or mobile installation, it's all convenience. If the equipment is installed such a way that it is inconvenient for you to operate it, chances are that you won't. If you don't use your HF equipment, you could miss out on the fun of operating an amateur station, your organization could miss out on the benefits of utilizing the full benefits of this communications medium, or you could put yourself in danger by being uninformed.

TRANSCEIVER

For a base-station installation, determining the location for your transceiver is simple. Just find a comfortable work area (such as on a large desk or table) and sit it there. For any other type of installation, you are bound to find yourself working against small space, an uncomfortable mounting location, and potentially harsh conditions. Then it's time to get creative.

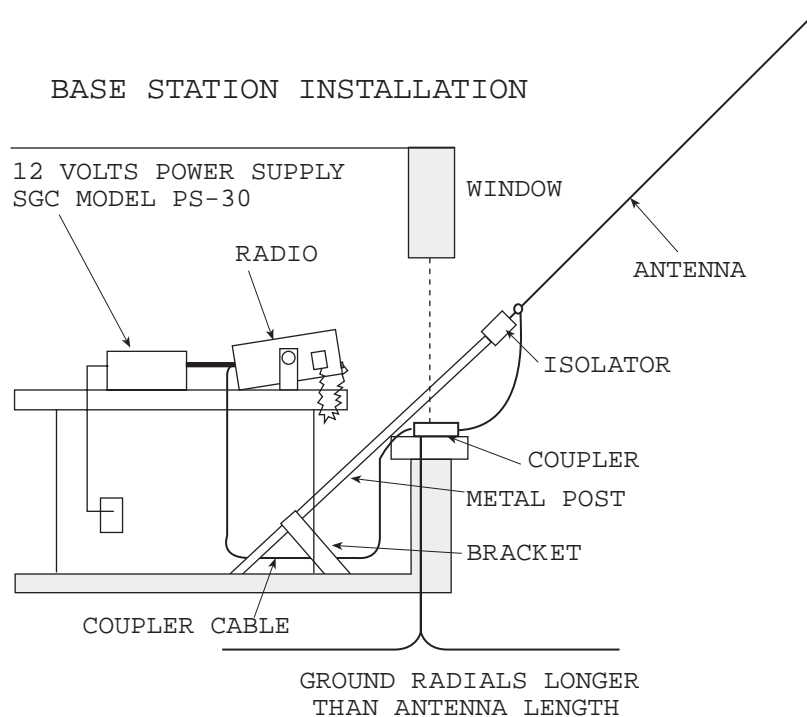

For most vehicular locations, it is best to mount the transceiver in the dashboard or control panel.

For most vehicular locations, it is best to mount the transceiver in the dashboard or just under the dashboard (or control panel). This way, all of the controls are right in front of you; if you are driving or flying, you will be able to easily operate the transceiver from the driver's seat. If more people are on board and more concentration needs to be put into radio operations, the radio can be operated by someone in the front seat beside the driver.

Because different types of transceivers are used in so many different applications, it is difficult to make recommendations on how they should be installed. However, it is often most practical to mount the equipment under the dash or control panel by merely screwing in the mounting plate. If there is any question as to the number of bumps and jolts that the radio will receive while installed in that location, use a shock mount. Shock mounts aren't always recommended, but it is better to play it safe with your communications equipment, especially in large helicopters or tugboats.

If you are installing a transceiver, such as the SG-2000, in a marine or car operating environment, you might want to take advantage of the remote head technology of the radio. With the remote head, you can place the SG-2000 in an out-of-the-way location (right next to your DC power source, whether it is an AC/DC power supply or your battery system) and set up the much smaller remote head somewhere else. That allows you to have the extra space to operate from a small, but convenient



With any HF transceiver, the power cables must be kept as short as possible.

location. When mounting the control head in this manner, use the remote head kit's gimbal mount. This mount allows you to change the control head angle to prevent glare on the display screen. Also, because the mount is adjustable, other operators can change the angle to their liking.

Running power cables As inconvenient as it might seem, whenever you operate a piece of electrical equipment, the power must come from somewhere, and power cables must be installed. With any transceiver, the power cables must be kept as short as possible. No wire or cable is 100% efficient and the longer that your cable is, the more power will be lost. As a result, if the power cable is too long, the transceiver will operate with less-than-optimum amounts of power. Also, the longer the power cables are, the better the chance that something could go wrong along the way (shorts, opens, etc.). SGC recommends that you use runs of less than 25 feet for your transceiver power cables; in any case, you should try to keep the cables as short as possible.

In addition to the specifications for the cable length, the cable gauge is also very important. If more power is running through the cable than it can accommodate, then it will overheat or simply prevent the transceiver from

Use #6 gauge stranded copper cable for power runs on 12-volt HF systems.

running at its full capability when transmitting. SGC recommends using #6 gauge stranded copper cable for power runs on 12-volt operation for the SG-2000. Some smaller gauges might work satisfactorily, but it's best to be safe and keep the installation as solid as possible--especially when it only involves a small additional cost for cable.

CONNECTING AND CONNECTOR TYPES

Connecting the ground The ground connector on the SG-2000 is simply a non-insulated ring terminal screwed onto a bolt. Remove the nut and the ring terminal. Run the ground wire or ground strap into the end of the ring terminal. Crimp it in place with a pair of pliers, then solder it, to make a good physical and electrical connection.

EXTERNAL MODEM,
WEATHERFAX AND HIGH
SEAS DIRECT™

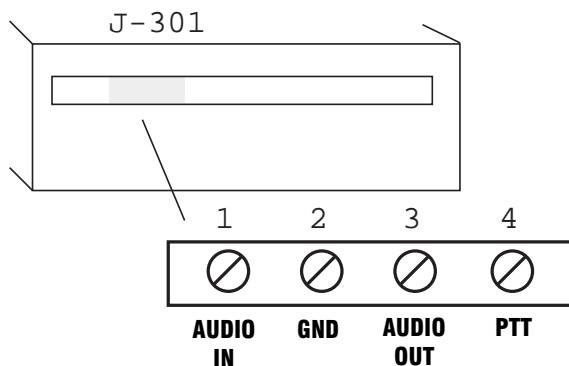

connector can also be used for some other functions, such as a key jack for Morse code (CW) operation. Just make sure that you have the mating connector soldered to the appropriate wires (refer to the SG-2000 manual for pin out information). Plug it in and you're ready to roll.

Connecting the feedline The SG-2000 uses a standard SO-239 connector for its RF input/output. Simply stick the end of the PL-259 plug (of the antenna feedline) in the SO-239 and screw the sleeve in place until it is tight. The connection is only electrical, so just tighten the connection with your hand, don't use any tools!

Connecting the audio I/O jack assembly On the SG-2000, the audio I/O, ground, and external PTT line are all contained on one jack assembly. The audio I/O means different things to different people, but in this case, it is intended for digital communications: to connect a modem, for weather fax, or for Telerex™. This

CONNECTING THE REMOTE CONTROL

The remote control head can easily be connected to the 10-pin connector located on the back panel of the SG-2000. The remote control is connected to the main unit via a 10-wire control cable. This cable is with wire and not fiberoptic cable so that it can quickly be field repaired if it becomes damaged. If more than one remote control head is used, then a junction box can be plugged into the 10-pin socket. This junction box can accommodate the connection of up to eight more remote control heads. For information on installing the remote control head kits, see the SG-2000 manual.

REAR PANEL CONNECTION FOR ADDITIONAL CONTROL H

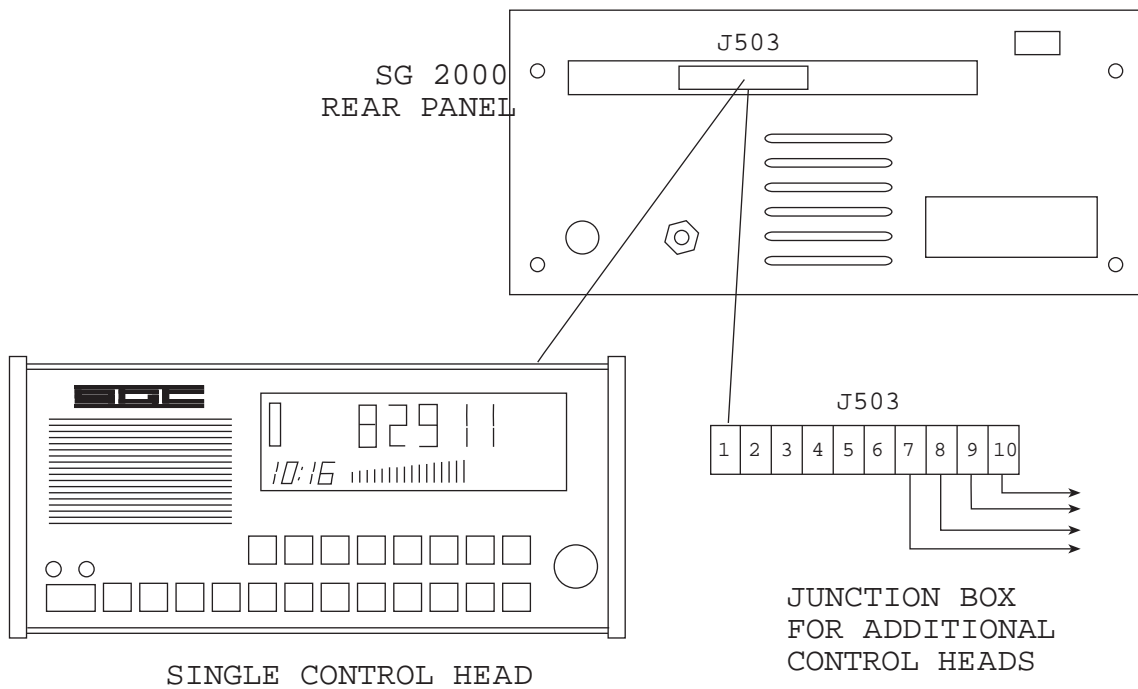

COUPLER

An antenna coupler must always be located at the base of the antenna, and usually they are mounted inside of the radio-operating area of a vehicle or in the radio room. With the SG-230 Smartuner™, you can mount this system in either an indoor or an outdoor location. Antenna couplers are placed at the antenna and they match the conditions of the antenna to the feedline in a very precise manner. Antenna tuner trimmers, on the other hand, are generally located at the transmitter output at the radio end of the coaxial feedline. Don't confuse these terms. Antenna tuner trimmers placed at the transmitter allow substantial losses in feedlines to be corrected in order to fool a transmitter into working correctly. The losses are dissipated through heat or to ground. A coupler installed at the antenna eliminates these losses by providing a proper match from the antenna to the feedline.

Antenna couplers are placed at the antenna and precisely match the conditions of the antenna to the feedline.

LOCATION

The most important factor when installing the SG-230 antenna coupler is to make sure that it is as close to the antenna as possible. The further the coupler is mounted from the antenna, the greater the transmitter signal

The antenna coupler should be mounted as close to the antenna as possible.

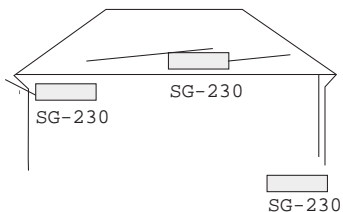

losses will be. Otherwise, the main concerns for the installation location are simply that it is secure and out of the elements (if possible). With the QMS (Quick Mounting System), you can mount the SG-230 on the outside of a vehicle and it will be secure, permanent or non-permanent, and able to resist the elements.

CONNECTION TO POWER

Connecting the power for the SG-230 is easy; just wire the + volts wire of the coupler to the +12-volts side of the battery and wire the black ground wire to ground. It is best to use #8 stranded copper wire with weather-resistant insulation for either indoor or outdoor use. Although you shouldn't operate a transceiver with long runs of power cable, the SG-230 draws small amounts of current, so voltage dropping isn't a problem. As a result, you can mount the Smartuner™ on an antenna tower and still rest at night, knowing that it is receiving the proper voltage. If the SG-230 is operating from a marine, aircraft, or mobile location, just attach the power cables to the battery of the

system. If it is installed at a base site with AC power, either use a self-recharging battery-powered system (such as a solar-charged battery) or connect the power terminals to a clean 12-volt bench power supply.

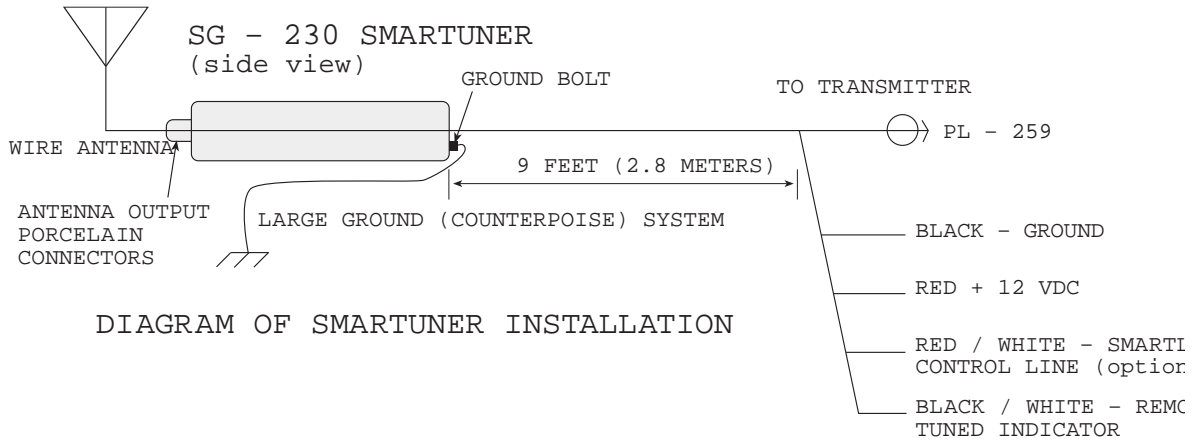

CONNECTION TO RF GROUND

The SG-230 Smartuner must be connected directly to the RF ground.

The SG-230 must be connected directly to the RF ground, which was covered earlier in this user (Remember - the RF ground is the other half of your antenna). As was described in that section, the connection between the ground cable and the ground (often a bolt) must make a solid physical and electrical connection. Then it must be sealed with spray paint or silicone bathroom caulking. Otherwise, one interesting and important rule is that your RF ground must be larger (area-wise) than your antenna. This will probably occur naturally with base stations, but it can often require quite a bit of work with mobile, marine, and airborne installations.

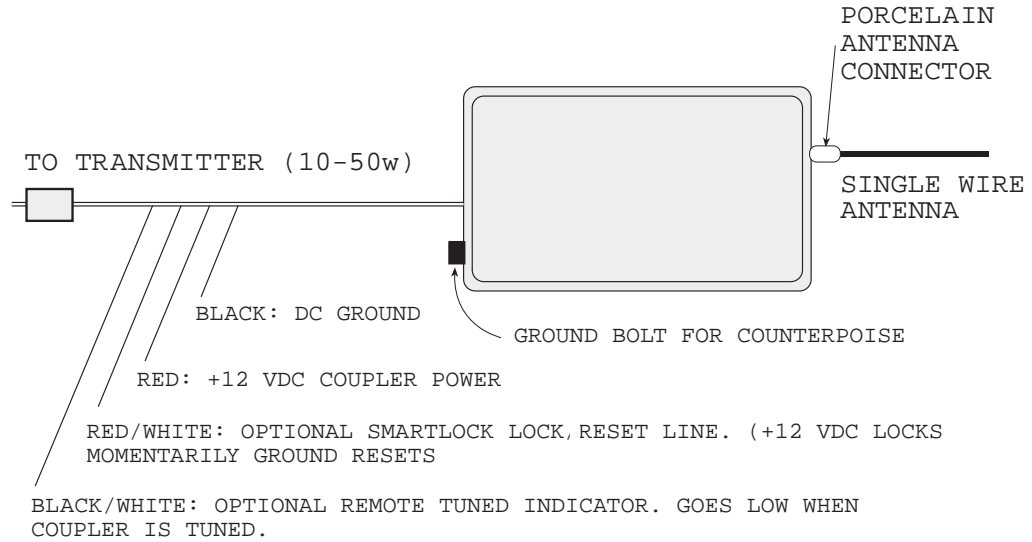
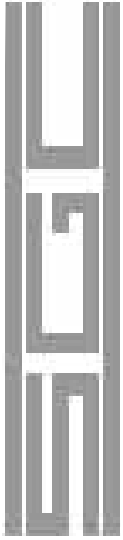

CONNECTION TO TRANSCEIVER

The SG-230 is merely connected to the transceiver via a piece of coaxial cable with a PL-259 connector on the end. Just plug it in and screw on the sleeve and you're ready to go!

CONNECTION TO ANTENNA

In most cases, the SG-230 will be connected to a simple wire antenna or to a vertical whip antenna. The single "hot" wire must be plugged into the antenna jack of the coupler. No coaxial cable should ever be installed to the antenna output jack of the SG-230. Always mount the antenna as high and far away from potentially interfering objects (a truck cab, a steel building, under a steel bridge, etc.) as possible. Otherwise, the signal from the antenna will be absorbed (to an extent) by the surrounding object and by the ground.

THE COUPLER IN A HARSH ENVIRONMENT

The SG-230 is built solidly, so that it can be used in a variety of environments. For marine operation, it is best for the coupler to be located inside of the boat. On power boats, the coupler can be mounted outside, but an additional protective housing is recommended. If the coupler is used in hot climates, it is best to install it inside of the QMS (Quick Mounting System), which will help shield it from the sun. Likewise, if the SG-230 is to be mounted on a tower, in either a hot or cold climate, it is best to turn a small plastic garbage can upside down and place it over the coupler; then mount the system. The garbage can will insulate the coupler from the sun and will also prevent large buildups of ice from forming.

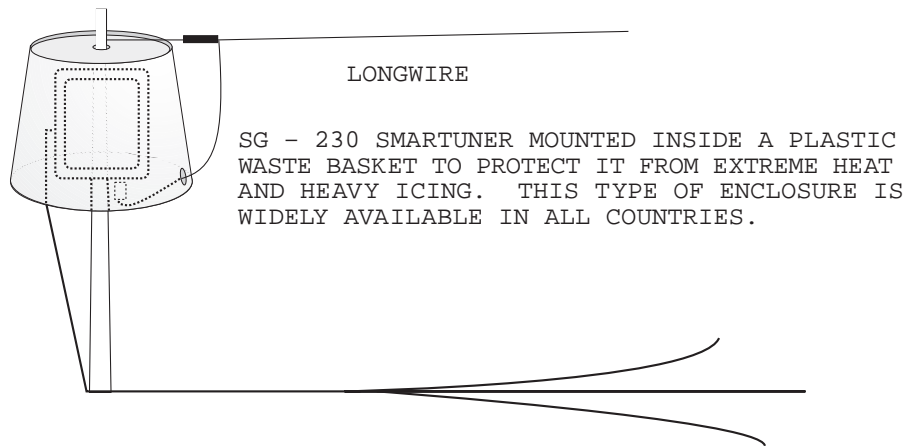

ANTENNA

Antennas have already been covered in this user guide, but their installation and what you can do to make them work in the space that you have available have not. Like most every aspect of HF communications, good operations generally require some materials, some work, and a great deal of creative technical designing.

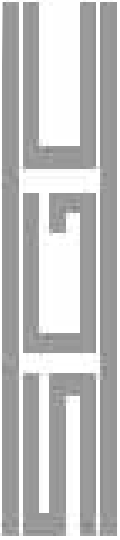

LOCATION

As was mentioned in the previous section, it is of utmost importance to have your antenna as high above the ground as possible, and as far away of any obstructions or contamination of appliance or industrial RF pollution (such as power lines, telephone lines, mills or other industrial machinery). In some cases, the ground will absorb quite a bit of the signal. A few examples of this kind of ground absorption are when an antenna, such as a dipole or a longwire, is located near the ground. "Near the ground" means that any distance less than a half wavelength above the ground will skew the signal pattern and absorb a certain amount of the signal. Considering that a half wavelength for the 40-meter amateur band would be 66 feet off the ground and a half wavelength for the 80-meter amateur band would be 122 feet off the ground, it will often be impossible for you to mount an antenna at such a height. Thus, the "as high as possible" rule is used.

Always mount the antenna as high as possible, and away from obstructions and interfering objects.

The best vehicle antenna location is on the roof or trunk.

Mobile and portable mounting locations are even more difficult to deal with because physical objects also absorb RF signals. As a result, your antenna has to contend with ground losses and signal absorption because the antenna is near the ground. The last thing you want to do is have your signals absorbed by a part of the vehicle. The best

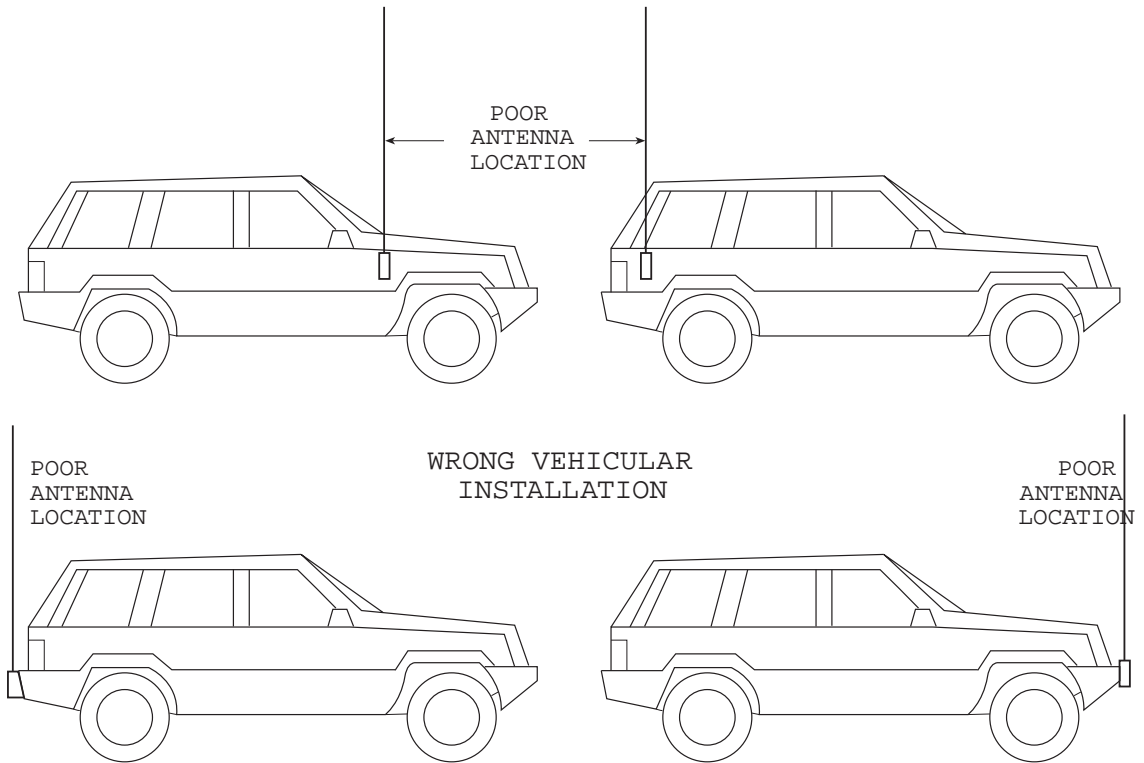

antenna mounting locations for a vertical whip on a vehicle are on the roof or on the trunk. If you mount the whip antenna on one of the bumpers or in the bed of a pickup, much of the antenna length will be below the height of the vehicle. Then a lot of the signal will get sucked down by all of that steel.

FEEDLINES

You have to get power from the transceiver to the antenna. To do this, you need a transmission line. As stated previously, use a high quality RG8, RG8X or RG58 coaxial cable with at least a 95% outer braid.

FEEDTHROUGH CONNECTORS OR HOLES

This is a very critical issue because at the base of the antenna high voltages (up to 10,000 volts) can develop. The feedthrough hole must withstand this high voltage. Generally, a high voltage porcelain feed connector, which is very common in the marine industry, is used. For a vehicular installation, the only way to go about this properly is to make a large (2 inch in diameter) hole with a fiberglass plughole. The wire will go through the center, with the minimum distances between the metal structure and the wire at least 1.5 inches.

FEEDLINE ROUTING

The feedline has a few peculiar relationships with the antenna elements. In the case of most antennas, the feedline should be run perpendicularly to the antenna element. In most mobile or portable installations, the feedline is short and it runs either perpendicular to the antenna or up to the antenna, so there is no problem.

In most cases, the feedline should be run perpendicularly to the antenna element.

Obviously, if the feedline at a base station should be run perpendicularly to a horizontal antenna, you can have some real problems with running the feedline in a safe and appropriate location. Fortunately, unlike unbalanced ladder line feedline, coaxial cable can be run along buildings and along or even under the ground. This makes feedline runs much more convenient. Also, the feedline doesn't have to run perpendicularly for its entire length; it's just best to have the last quarter wavelength (as compared to the operating frequency of the antenna) run this way.

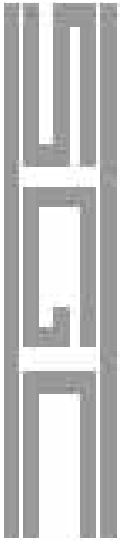

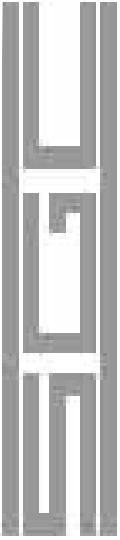

HARSH ENVIRONMENTS

All solder connections should be electrically and physically solid, and protected by silicone sealant.

Because most antennas are located outdoors, they will be subjected to harsh weather. You don't have to worry about this if you are using SGC antennas because they are built to last in harsh environments. If you are building your own antennas, be sure to use strong materials, solder and connect them soundly, and waterproof them. All solder connections should be electrically and physically solid. Then cover them with silicone bathtub caulking, tape them tightly with electrical tape, and smear more caulking overtop. If you are installing a long-term antenna, you don't want the joints to break down after only six months or a year in the air.

NOISE AND INTERFERENCE

Noise and interference are the worst problems with HF communications. Because the radio signals can travel thousands of miles around the world, the sources of noise can also travel great distances and plague HF users. In the early days of radio, the users of the HF (and lower) frequencies found that the radio spectrum was filled with static and thunderstorm crashes. In today's industrial and electronics-based world, those natural noises have been joined by countless forms of man-made interference. There is little that you can do to avoid the natural interference, but dodging the man-made interference is a fine science. The simplest rule is to stay away from houses or buildings.

NATURAL INTERFERENCE

Natural interference is caused by such things as solar activity and thunderstorms.

The worst form of natural interference is caused by lightning. The radio signals from the massive bolts of electricity can easily propagate for hundreds of miles and cause what are typically known as static crashes across the HF spectrum. Aside from avoiding operations during local thunderstorms, there is little that you can do to avoid this interference. Snow and rain also create static that will cause communications problems.

MAN-MADE INTERFERENCE

Man-made interference is emanated from most any location where electrical appliances are being used.

**Man-made interference:
neon signs, fluorescent
lights, faulty
televisions, electric
motors, engines, faulty
power line
transformers, etc.**

However, the worst causes of interference are caused by neon signs, fluorescent lights, arc welders, faulty televisions, motors and engines, and faulty power-line transformers. If you can choose the location for your radio installation, you are much better off setting up in a rural area--chances are that there will be a relatively small amount of man-made interference. For base-station operation, you should not operate fluorescent lights. Otherwise, there is little that you can do to persuade local businesses to remove their neon advertising signs or change back to incandescent lighting.

For mobile operations, you are stuck in a noisy environment. The ignition system, engine, alternator, electrical system, and wheels all produce electrical noise. Severe noise from the ignition system is caused by the sparks of electricity at the spark plugs. If you have a diesel car or truck, which has no spark plugs, you are spared from this noise. But the engine and alternator both produce noise from the cycling metal (the pumping cylinders in the engine and the spinning coil of wire in the alternator). Electrical signals from passing wires (such as for the turn signals, etc.) can sometimes interfere with a nearby HF radio. The last form of vehicular HF interference occurs when driving: the tires roll on the pavement (both nonconductors) at high speeds and build up static electricity.

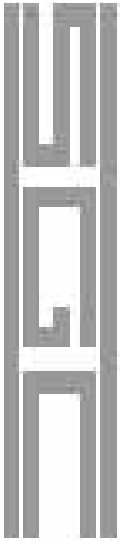



NOISE REMEDIES AT THE TRANSCEIVER

Even though you might be stuck in a location where man-made noise is abundant, you don't have to be bothered by this interference. A number of different techniques can eliminate some or all of the noise at the source, or by filtering or changing that noise.

DIGITAL SIGNAL PROCESSING (DSP)

DSP is one of the new audio technologies that is just starting to take off. With DSP technology, the radio audio is turned into digital signals and certain patterns, such as noise patterns, can be filtered out. In some cases, it might even be possible for the audio signal to be partially reconstructed. It won't be long until DSP technology is contained in most every radio. Just as digital frequency readout boxes were available for every transceiver 25 years ago, separate DSP boxes will soon look archaic and it will be assumed that the technology will be in every radio 25 years from now.

NOISE BLANKER

The noise blanker is a circuit that is effective in limiting quick, "pops" in the audio. When a loud, quick noise occurs, the noise blanker turns the audio circuit off for a very brief amount of time. The circuit is turned off and on so quickly that you don't even realize that it happened. Noise blankers only work with brief "pops;" if a noise blanker is used with a constant noise source, the audio will be reduced and effect will be similar to using an attenuator.

MAGNETIC ANTENNAS

Magnetic antennas have nothing to do with car whip "mag mounts" or a tacky antenna that you could stick on your refrigerator. These antennas are all types of loop antennas, which receive the magnetic component of radio waves and not the voltage component. As a result, although the received signals are at a lower level, the interference is also greatly reduced.

CHANGE OF FREQUENCY

If you can't beat it, avoid it. Some types of interference are centered around particular frequencies or bands. For example, fluorescent light noise is often worst at the lower frequencies. If you can move up into the 10 MHz (and above) region, this type of interference will often drop significantly. Of course, these types of interference can vary, so you will have to check the bands and determine which frequencies are best. Of course, your ability to change frequencies will depend on what frequencies you are allocated to operate on.

NOISE REMEDIES AT THE NOISE SOURCE

In vehicles with traditional gas-fueled engines, ignition noise is one of the most damaging forms of interference. Without some sort of ignition noise suppression, it will be difficult to receive, and thus to make any contacts on the HF bands.

ISOLATION AND BYPASSING

Quite a bit of engine noise can be eliminated if various parts of the vehicle are isolated and bypassed. Just purchase some 0.01- to 0.1-microfarad 100-volt ceramic disk capacitors from an electronics parts house (such as Radio Shack). Then install one capacitor inline with each lead from the battery and from the alternator. Make sure that all solder joints are solid, clean, and sealed. If the ignition system is noisy, add a capacitor in line with the primary side of the ignition. Don't put capacitors in any other location around the ignition or you might reduce and delay the voltage to the ignition. If this is the case, you will have countered the effect of the ignition and the car might not work!

Engine noise can be isolated and bypassed.

Another method to reduce noise is to place resistance in line with the spark plugs. The resistances can be added near the spark plugs, in ignition cable, or in the spark plugs themselves. When resistors are added near the spark plugs, they are often installed at the distributor towers or spark plug terminals, moulded into the distributor rotor, towers, or the center contact button.

The most commonly used ignition noise suppressor is resistance ignition cable. This cable is available in either low-resistance types (3000 to 7000 ohms) or high-resistance types (6000 to 12000 ohms).

The last method is to use noise-suppressing "resistor" spark plugs. These special spark plugs contain resistance elements to reduce radio-frequency radiation from the ignition coil and to virtually eliminate the high-frequency part of the spark.

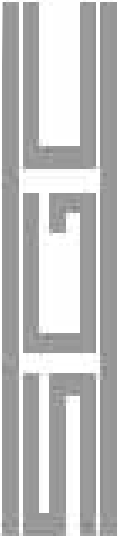

Although you can use resistor spark plugs with resistance ignition cable and with external suppressors, it is not advisable to mix external resistance suppressors with resistance ignition cable. Also, do not use external resistors if resistors are already built into the system.

Be sure to regularly check and repair (if necessary) the ignition system in your vehicle if you are using a transceiver inside. Suppressor cables can be damaged if you handle them roughly, and they can simply deteriorate with age. Occasionally check the connections and be sure to pull the connectors off carefully. If the connectors are damaged, it is usually much more effective to purchase a new suppressor cable than to repair one.

Replace any parts in the electrical system that are worn or corroded at the connections. Replace the distributor cap and rotor if the rotor tip and the contacts inside of the cap are wearing down. If the connections in the ignition system are worn, severe interference could result. If a miniscule (a fraction of a millimeter) gap is created in this system, the electricity will have to jump the space, and will radiate (radio interference). These miniscule gaps can be created by loose connections or by dirty connections. Be sure to check them and replace them if necessary.

BONDING

Ground loops occur when two or more components are connected to different "grounds" that are not at the same potential.

Bonding was covered earlier in the section with grounds for marine installations. It involves using large chunks of copper foil (or possible other materials to interconnect all large pieces of metal to form the ground. Bonding will prevent the possibility of having ground loops (which cause noise when receiving) in your system. Ground loops occur when two or more components are connected to different "grounds" that are not at the same potential. In a more general sense, bonding is the process of linking the components of any ground. When bonding the ground in a vehicle, use ground straps, lockwashers, and self-tapping screws to bond different parts of the car together.

STATIC COLLECTORS

You can cure front-wheel static and "pops" by installing static collector rings inside of the front wheel caps.

Automobile static buildup can also be bled-off by attaching an automotive ground strap to the car frame and having it drag along the pavement. Almost any auto parts store will have these ground straps.

SHIELDING

Shielding typically involves using metal to prevent noise signals from entering your radio. This could mean using a metal cabinet (instead of a plastic cabinet) or using coaxial cable (instead of ladder line feedline). With having an inboard engine in a boat with a nonmetallic hull, it means shielding the engine. To do so, you must shield the entire engine compartment with copper or bronze screening.

GROUNDING

If the system is grounded, the typical "ground hum" should not plague your radio. See the section on grounding for more information on installing a good ground.

MOVING THE ANTENNA

Even if you can't eliminate all of your noise problems, you might be able to avoid them by moving your antenna. On a vehicle, you should move the antenna as far from the engine compartment as possible. In a base location, it could mean moving the antenna from the front yard to the back to keep it from being nearby and parallel to noise-producing power lines.

**Sometimes, simply
moving the antenna
reduces noise.**

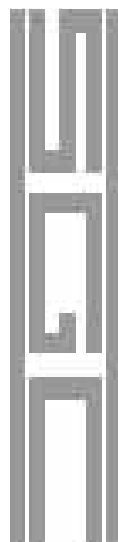

POWER CONCEPTS

The power is typically the output of the transceiver in watts. Power could be measured in a number of different ways, but output power is the most common and most practical method. The power is measured on a wattmeter, which is connected between the transceiver and the antenna. Some antenna tuners have built-in wattmeters so that you can determine the output power.

SETUP FOR ELECTRICAL CHECK OUT:

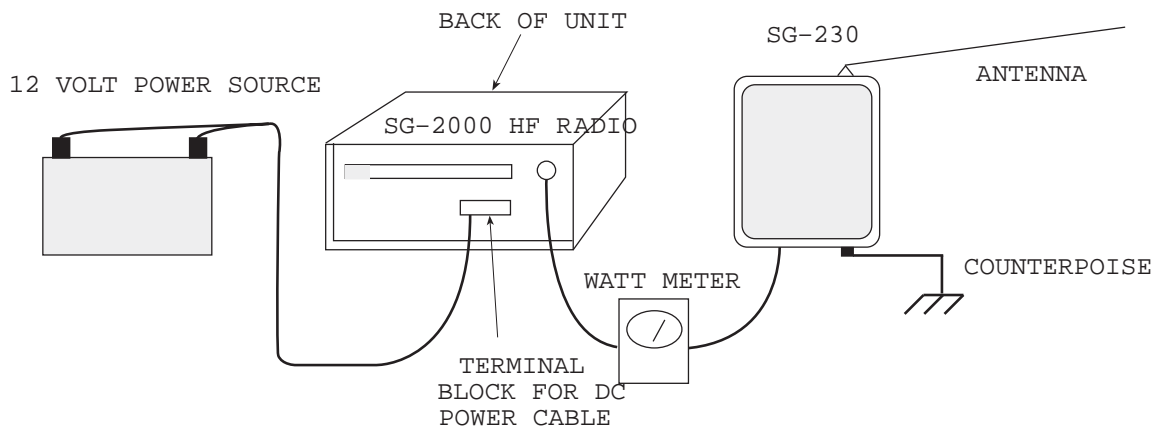

FORWARD POWER

The forward power is the amount of power (in watts) that is actually emanating from your antenna. The forward power is the output power minus the wattage that is lost in the SWR and through the feedline. The forward power can be measured with a wattmeter.

Forward Power is the amount of power actually emanating from the antenna.

REFLECTED POWER

The reflected power is the amount of power (in watts) that is reflected back from the antenna (in the form of standing waves). This power is reflected back to the transmitter as a result of antenna mismatch. The lower the reflected power, the better; this power eventually becomes dissipated by the output section of the transmitter, and it could damage it. The reflected power can be calculated with a reflection meter.

Reflected Power is the amount of power reflected back from the antenna.

STANDING WAVES

Standing waves are waves of RF signal that are reflected back to the transmitter as a result of an impedance mismatch. The reflected power is a measurement of the amount of power that is wasted in standing waves. Likewise, the VSWR is the ratio of standing waves in a radio transmitting system.

VSWR

The VSWR rating represents the voltage standing wave ratio in a system. The ratio represented is actually either the ratio of the maximum voltage to the minimum voltage or the maximum current to the minimum current. For most people, this isn't important. What is important is that you need to keep the ratio as low (close to 1:1) as possible. A VSWR (usually known as SWR) of more than 3:1 is too high and you either need an antenna coupler or (if you don't have one) you need to trim your antenna to the correct (resonant) length. The SWR is typically measured on an SWR meter, although this function is sometimes built into transceivers and antenna tuners.

VSWR should always be kept as low as possible.

FIELD STRENGTH

The field strength is the measure of a radio signal as it is being transmitted from the antenna. The field strength is usually determined in microvolts per meter away from the antenna. To measure this voltage, you must use a field-strength meter.

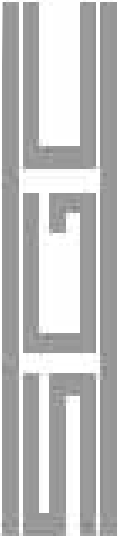

FREQUENCY

An accurate Digital Frequency Readout is an essential HF transceiver feature.

As described very early in this user guide, the frequency is the number of radio waves that pass by a given point in a second. The frequency is "where you are" on the radio. It also determines how far your signal can travel and when it can travel the furthest. It is very important to have an accurate digital frequency readout on a transceiver or your signal could stray into areas where it is not authorized and cause potentially dangerous interference. The frequencies of various transceivers and other equipment are determined with a frequency counter.

GAINS AND LEVELS

Gain and levels describes a number of different aspects of radio. Gain describes an increase in a signal, whether current, voltage, or power. On a transceiver, the gain control

dB Gain describes an increase in signal level.

Level refers to how loud the signal is.

is what controls the volume. In an amplifier, the gain would be the improved output signal (in dB) over what was input to the amplifier. With an antenna, the gain is the improvement in signal strength (in dB) over a reference antenna (usually an omni-directional antenna or a half-wave dipole).

The level of a signal usually refers to how loud it is. As a result, the levels of a received signal are usually measured on an S-meter (see the next section) or on a linear LED meter.

DO-IT-YOURSELF LIGHT-BULB DUMMY LOAD

Any time that a transmitter is used, it must be outputting into a load. A load is anything that the output power can be pumped into. If the transmitter is operated without any sort of load connected, the final amplifier stage could become severely damaged. The problem is that you should never test a transmitter on the air for the first time, if you are unsure about how to operate it, and if you are unsure whether it is working properly. You could create harmful interference to other stations.

To test transmitters without actually operating into an antenna, dummy loads were created. A dummy load is a load that will dissipate the energy from the transmitter instead of emanating it into the ionosphere. Nearly all commercial dummy loads are large oil-filled cans. These dummy loads change the transmitted energy into heat, which is absorbed by the oil. Because different transmitters output different amounts of power, different sizes of dummy loads must be used. Dummy loads for typical amateur powers (under 500 watts) are relatively inexpensive and are readily available.

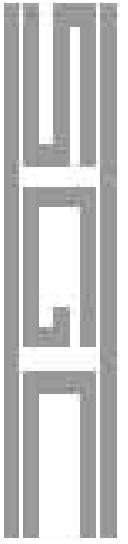

Unfortunately, when you use a can-type dummy load, you can't see "what's happening" with your transmitter. In this case, you can use a light-bulb dummy load to test your transmitter. Here, the light bulb is directly connected to the output of the transmitter and it dissipates the RF energy as light. The light bulb dummy load is more useful than the oil-can type because you can guess how much power is being output, you can see the voice modulate the SSB (the light will flicker with your voice peaks), and you can tune the transmitter for maximum output (if the transmitter is an older model that requires tuning).

Before building or using the light-bulb dummy load, remember that these models typically don't dissipate the transmitter's output as well as an oil-can dummy load. The result is that RF will "leak" out; I have heard a few stories of amateurs who were heard around town while operating their transmitters into a light-bulb dummy load. If you use this system, make sure that you test the equipment on a clear, harmless frequency (NEVER test with the transmitter set on an emergency frequency, such as 2182 kHz).

SGC recommends that you build the light-bulb dummy load with the following parts (although I have made one with an old light fixture and a makeshift version with just alligator clip leads and a light bulb):

- * AC socket to cable with a PL-259 connector
- * AC socket to cable with alligator clips (needed with coupler)
- * Light bulb to AC adapter
- * 75 to 125 watt light bulb, 120 to 220 VAC
- * SG-2000 transceiver
- * SG-230 coupler (optional)

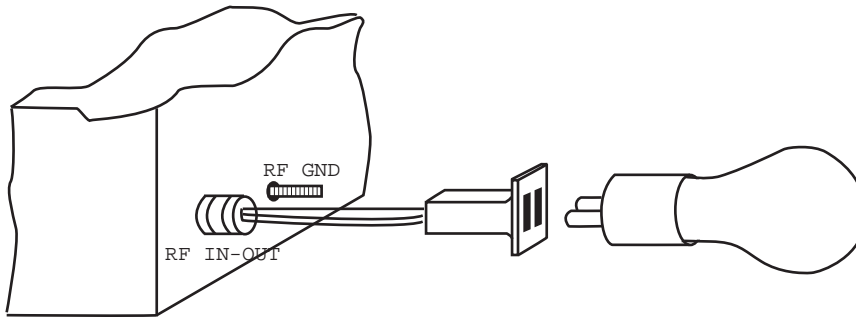
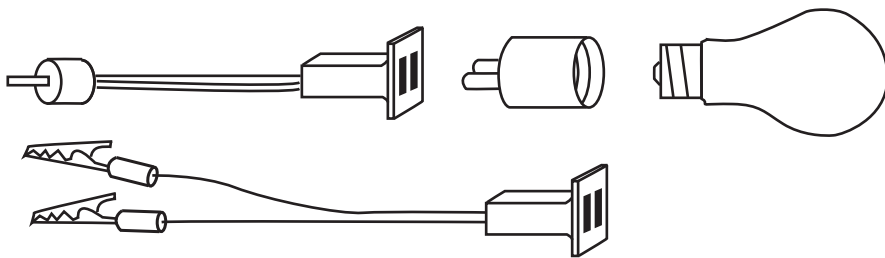

SG-2000 RADIO

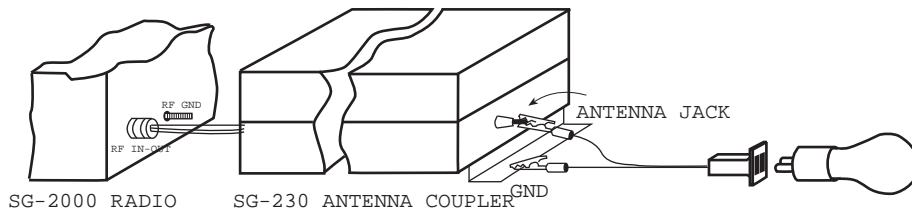

RADIO TEST PROCEDURE

1. Connect the transceiver dummy load to the SG-2000 RF in/out jack.
2. Turn on the radio, set the CW mode, and set the power to HI.
3. Key the PTT switch on the microphone and look at the light bulb. If the dummy load is connected and the radio is transmitting, the light should turn on.
4. Set the power to LO.
5. Key the PTT switch on the microphone and look at the light bulb. If the dummy load is connected and the radio is transmitting, the light should turn on. Notice that the light is not as bright as in step 3 (the power switch is set to LO).
6. Set the power to HI.
7. Set the SG-2000 mode to A3H.
8. Key the PTT switch on the microphone and look at the light bulb. The light should come on if the radio is transmitting. Notice that the light is not as bright as in step 3.
9. Set the SG-2000 to A3J mode.
10. Key the PTT switch on the microphone and talk into the microphone. Notice that the light turns on when you talk.
11. Set the SG-2000 to the A3A mode.
12. Key the PTT switch on the microphone and talk into the microphone. Notice that the light bulb comes on when you talk.

COUPLER TEST PROCEDURE

1. Connect the coupler to the SG-2000.
2. Connect the coupler dummy load to the SG-230 antenna jack.
3. Turn on the SG-2000 and the SG-230.
4. Set the SG-2000 to the CW mode.
5. Key the PTT switch on the microphone and look at the light bulb. The light should turn on if the coupler has completed its' tuning cycle and if the radio is transmitting.
6. For further testing, follow steps 4 through 12 of the radio test procedure.

Note: The light bulb might not turn on immediately if the coupler has not yet been tuned for the frequency of the transmitter. The output power (light-bulb brightness) is greatest when the coupler is properly tuned.

INSTRUMENTS

WATTMETER

The wattmeter is a test instrument that can be connected in between the transceiver and the antenna to show exactly how much power is being output by the transceiver.

SWR METER

The SWR meter is used to measure the standing-wave ratio of an antenna at a given frequency. If the transceiver has a built-in SWR meter, it will automatically show the SWR. If the SWR meter is in a separate unit or is contained in an antenna tuner, you might need to tweak a few knobs or settings to get the accurate SWR.

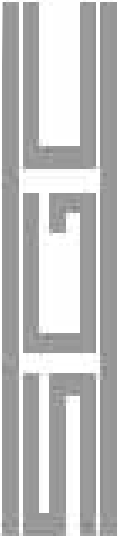

FIELD STRENGTH METER

The field strength meter is a small handheld meter that is used to determine the strength of the signal (in microvolts per meter) as it is being transmitted from the antenna. Field strength meters are typically very simple radio circuits with a meter and a tuner.

FREQUENCY COUNTER

The frequency counter is somewhat like a field strength meter in the sense that they are both handheld and contain radio circuits. With some frequency counters, you can walk near an operating transmitter, push one button, and the exact frequency of the transmission will be displayed. Frequency counters can be used to calibrate a transceiver.

Frequency Counters can be used to calibrate a transceiver.

If you don't have a frequency counter, you can exactly tune in to one of the WWV broadcasts (with the receiver in SSB). You can then see how closely the receiver is on frequency.

IMPEDANCE BRIDGE

An impedance bridge is used to determine the impedance of a circuit. An impedance can be handy when operating an HF radio station because you can determine the impedance of an antenna that you are using and if you need to match the system differently.

S-METER

An S-Meter shows the strength of the signal being received.

An S-meter shows the strength of the signal that is being received (in decibels). The specifications for S-meters vary from one type of receiver to another, so the signal ratings aren't terribly useful, except for your own personal use. As a result, some newer receivers use a more linear system of LEDs or LCDs to show the signal rating (usually 0 to 10).

CHAPTER 5

AMATEUR RADIO

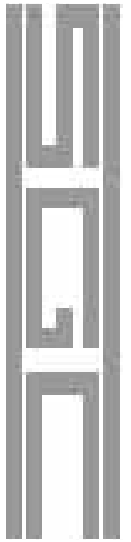

AMATEUR RADIO

Amateur radio is the private, personal way to experience HF communications as a hobby, rather than as a profession. With amateur radio, you have the opportunity to talk with, send data to, or transmit pictures to thousands of people around the world. In addition to the wonderful possibilities to communicate with and befriend others, the potential to learn about a vast array of topics is amazing. All of this can occur while learning about HF radio, electronics, and computers. In fact, many people become involved with amateur radio just for the opportunity to participate in creative home construction and engineering projects. Amateur radio is truly the doorway to a whole new world.

The first step in becoming an amateur radio operator is to get a license.

The first step to becoming an amateur radio operator is to get a license. This isn't the CB band, where you can get a transceiver and hit the airwaves. Doing so (if you are located in the United States) will certainly result in a visit or letter from the Federal Communications Commission, which regulates radio activity in the U.S. The FCC agent might also feel inclined to give you a Notice of Apparent Liability (NAL, basically a fine) for as much as \$100,000 for unlicensed radio operation.

In order to avoid a large fine and still experiment with the magic of HF radio, you must become licensed by the FCC. The license process consists of two parts: the first consists of transmitting and receiving Morse code. The second part is a written test that consists of a number of multiple-choice questions about radio theory.

Five different license classes exist for amateur radio on the HF bands: Novice, Technician, General, Advanced, and Extra. Each of these licenses has more privileges and each is more difficult to achieve. For example, with a Novice or Technician license, you are limited to operating in the CW mode only, with reduced power, and only in certain segments of the amateur radio bands. With a General license, you are able to operate with full amateur power (restricted to 1500 watts PEP output) and you are able to operate with any mode, but are restricted on some frequencies. Advanced and Extra class tickets each allow the operator to use a few more segments of frequency space. With an Extra class license, you can do everything that is allowable with an amateur license. For more information on amateur radio licensing, check out the code practice cassettes, license manuals, and beginners books on amateur radio from: the American Radio Relay League, 225 Main St. Newington, CT 06111.

A General License allows you to use full amateur power, in any mode, but does not allow use of every amateur frequency.

THE U.S. HF AMATEUR BANDS

160 meters 1800 to 2000 kHz

80 meters 3500 to 4000 kHz

40 meters 7000 to 7300 kHz

30 meters 10100 to 10150 kHz (max. power 200 watts PEP output)

20 meters 14000 to 14350 kHz

17 meters 18068 to 18168 kHz

15 meters 21000 to 21450 kHz

12 meters 24890 to 24990 kHz

10 meters 28000 to 29700 kHz

AMATEUR OPERATIONS

The transmissions on the amateur bands all consist of two-way, noncommercial communications. That means that you may not broadcast, cause willful interference to other stations, or receive payment directly (or indirectly) for any communications. As far as amateur radio is concerned, broadcasting occurs when music or entertainment is aired for more than the one person that you are communicating with. Noncommercial communications means that you can't make business calls or sell anything over the radio. It is also a violation of FCC rules to accept money for communicating a message from someone to another operator. Profanity, as defined by the FCC, is also banned on the amateur bands. If you are unsure about certain words, watch TV for a while to get a hang of what you can and can't say on the air. A better guideline might be to consider what might offend someone else, then try to avoid those words. It sure beats an FCC fine or the loss of your amateur license.

Transmission on amateur bands all consist of two-way, non-commercial communications.

Aside from these points, you are free to talk about most anything that you please. These are the hobby aspects of amateur radio. You can get on the air, call someone, and have a conversation. To make things more interesting, many amateurs have established little networks for a variety of reasons. A network is an established group that meets at a particular time every day, week, or month. The group is run by a net control, who mediates the discussions. Then everyone can participate in a round-robin discussion. The nets cover a huge variety of topics, although most are informational and not nearly as rude or controversial as some of the Usenet groups on the Internet. Because of these amateur radio nets and because of shortwave broadcasting, HF/shortwave is sometimes called the original information highway. For more information on amateur radio operations, see The ARRL Operating Manual, which is a massive tome that covers most every aspect of amateur radio operations.

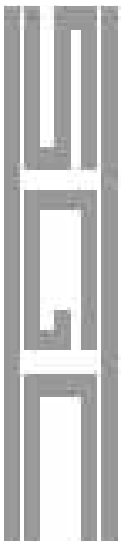

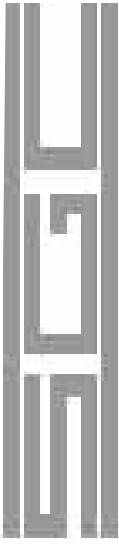

This user guide has covered many aspects of HF communications, so this section on the communications potential of amateur radio covers primarily old material. The SG-2000 has an output power of 150 watts PEP, so it does not even approach the amateur legal limit. However, most amateur transceivers only have 100 watts (or less) of output power, and they are intended to be operated with a station amplifier.

The standard 100-watt power level of most transceivers is plenty in most situations. The 150 watts from the SG-2000 gives you a bit extra power if you need it; if you don't, you can reduce the power to 50 watts. With 150 watts, signals on the frequencies below 5000 kHz are generally regional: restricted to a daytime range of several hundred miles and a nighttime range of 1000 to 2000 miles. Between 5000 and 10000 kHz, you could expect a range of 500 to 1000 miles during the daylight hours and 2000 to 4000 miles at nighttime. From 10000 to 15000 kHz, you can expect a range of 1000 to 4000 miles during the daytime and the same range for part of the nighttime hours. From 15000 to 30000 MHz, the range is from 1000 to 4000 miles, but the range is virtually unusable at night.

With the SG-2000, a good ground, and a good antenna, you should be able to regularly contact other amateurs around the block or around the world. However, if you need to regularly communicate with many stations in distant, remote locations, you might consider using a high-quality amplifier. One of the sturdiest amateur power amplifiers on the market today is the SG-500 Smart PowerCube. This amplifier is fully automatic and is rated to continuously output 500 watts PEP.

**With an SG-2000,
a good ground,
and a good
antenna, you can
contact amateurs
around the block
or around**

COMMERCIAL LICENSING

The U.S. FCC issues licenses for the operation of many classes of radio stations. This includes ham radio stations, commercial marine shore stations, shipboard stations and those that involve kinds of mobile applications (such as systems aboard aircraft). There is an exception. Stations operating under the auspices of the U.S. military and stations in the Military Affiliate Radio System (MARS), are exempt from the licensing requirements of the FCC, but are subject to military rules. Most countries have similar regulations.

Boatowners must have a Vessel Marine License and a VHF License before lawfully transmitting any HF marine frequencies.

Boat owners must meet a number of licensing requirements before lawfully transmitting any radiotelephone messages. According to FCC regulations, the following must be on board the vessel: 1. a valid ship radiotelephone station license, 2. a valid radiotelephone operator license, and 3. a radio station logbook.

Anyone who uses the radiotelephone should be thoroughly familiar with approved communication procedures and operating features of the equipment. Although anyone can use the radiotelephone, an operator holding a Restricted Radiotelephone Permit must be on board when any transmissions are made. This operator is responsible for the radio emissions whenever the radio is used. No examination is required to obtain this license. This operator's permit does not authorize adjustments to the transmitter, and all tuning adjustments to any

radio equipment must be performed by an individual who holds a second-class commercial radiotelephone or radio telegraph license.

The ship station license is issued in the name of the owner and vessel, and is not transferrable to a new owner on the sale of the boat. When a boat is sold, the owner must return the radio license to the FCC and the new owner must apply for a new license. Call signs stay with the boat if the boat is documented, but the new owner must apply for a license to operate the station.

STATION LICENSES

Generally, the charge, if any, for filing a station application is modest. If you are planning to operate a U.S. commercial two-way radio station (such as aboard a fishing boat), simply call the local FCC regional office (12 such offices are located around the country) and ask them to send you the appropriate paperwork. If you are located outside of the U.S., check with the government authorities.

If you do not plan to operate from aboard a ship, but need to communicate with vessels on a regular commercial basis, you might qualify for a private coast station license. The FCC also has licenses available for specialized needs, such as long-distance aviation communications.

A current printed copy of rules and regulations governing commercial marine operations is available from Fair Press Service, P.O. Box 19352, Washington DC 20036-0352. The telephone number is (202) 463-7323. There is a charge for this publication.

OPERATOR LICENSES

In the U.S., a radio operator license is required. The person operating a commercial station aboard a pleasure craft (or any ocean-going vessel under a certain tonnage) must have an Operator Permit to use the radio of an appropriately licensed vessel.

It is simple to obtain the commercial Operator Permit, which is simply an agreement to use the radio properly, not to use profanity, and not to use the radio for illegal purposes. Just sign your name, write in your mailing address, and a few weeks later the permit will arrive.

If you intend to repair commercial radio equipment, however, the requirements become stringent very quickly. A General Class Radiotelephone License is required to make adjustments or repairs on any equipment used in the commercial service.



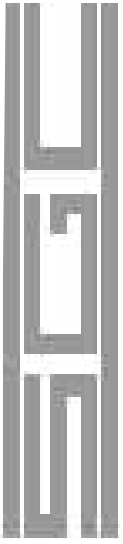

NOTES

CHAPTER 6

MARINE OPERATIONS

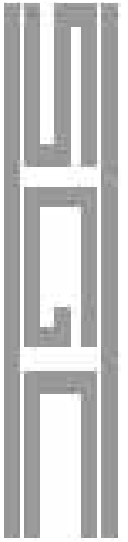

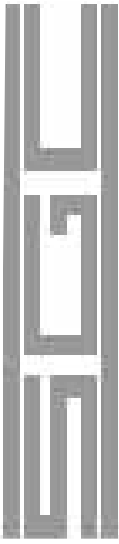

MARINE OPERATIONS

Because so many different stations and frequencies make up the HF bands, you must learn how to operate the marine radio on the correct channels and times, using the correct procedures.

The best way to learn which channels will work at any given time of day is to listen to your radio. Leave it turned on while the boat is docked and while you are underway. Change the channels and listen to all of the bands. Before long, you will know which bands are best to use at different times of day.



Keep a logbook of the stations that you hear to help you to learn which band is active at any time of day. Use the logbook to record the name and location of every station heard, the time, your location, the time of day, and the frequency band. Of course, according to FCC regulations, you must keep a logbook of all outgoing traffic from your boat to any other station. Your logbook should contain the name and call sign of each vessel called, the time of day, channels used, the date, and your signature.

If the station that you hear is weak, you will probably have difficulty contacting them. Remember that these shore stations have 1000- to 10000-watt transmitters and directional antennas. They will invariably be heard by the vessel much louder than the vessel will be heard by them. If you hear the shore station loud and clear, they will usually be able to copy your transmission.

Never interfere with transmissions in progress or prolong your conversation, tying up the frequency.

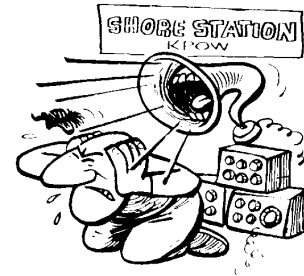

Radio communications are regulated by international treaty. Be polite and use proper procedures and manners to make your communications successful. Do not interfere with transmissions in progress or prolong your conversation so that others cannot use that frequency. Do not transmit on channels not assigned to your class of ship station. Do not adjust your own transmitter, unless you have a license to do so.

SHIP-TO-SHORE CALLS

In order to make a call, select a channel and station that you want to contact. Be certain that the channel is not already in use. Most ship-to-shore channels are set-up for duplex communications: you operate on one frequency and the shore station operates on a different frequency. Because you can only hear one side of the channel, wait to

make sure that you don't interfere with a call already in progress. If someone is talking to the shore station, you will not hear that operator; you will only hear the shore station's responses.

After the operator states that the frequency is clear, immediately call the shore station. Identify your ship and its location. The operator will be listening for calls carefully because it is likely that others are waiting also. Even if your signal is weak, it will very likely attract the operator's attention. Even if other stations are waiting to place traffic, the operator will at least acknowledge your call. The operator will then "list" you and indicate approximately how long you have to wait until it's your turn.

TELEPHONE CALLS

When transmitting, speak slowly and finish your messages with "over" to indicate you are finished with that thought and waiting for a response.

Contact the High Seas operator by calling the name of their station and identifying your vessel's name and call sign. Advise your location and announce the channel that you are calling on. This will permit a faster coast station response time because most operators are listening to as many as 20 channels at once. Repeat this sequence three times. The High Seas operator will ask how he or she can help you. If you wish to place a telephone call, two operators will need to be involved. As soon as a commercial-quality circuit is established to your vessel, the technical operator will then connect you to a dialing operator. This operator will, in turn, obtain the billing information and place the telephone call for you. You can call collect; bill the charges to your business, home phone or credit card; or use a marine identification number.

"Out" indicates to all listeners that you are finished and no longer need the channel.

When using your marine SSB transceiver to transmit, speak slowly and finish your messages with "over" to notify the person at the other end that you have finished speaking and that you are waiting for his or her response. You can, but should not, interrupt the other person by pressing your microphone button and talking. If you do this and the other party is still talking, you will miss what was said.

When the land party hangs up, billing timing will automatically stop. The operator will come on to confirm if you have completed your call, and ask if you have additional traffic. When you confirm that you are finished, the High Seas operator will announce his or her call sign and "clear." You then respond with your vessel name, call sign, and "out." "Out" indicated to all listeners that you are finished and no longer need the channel. Further, this exchange of words is required by international radio treaty and FCC rules.

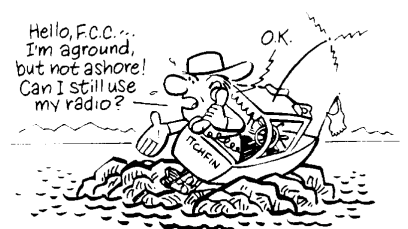

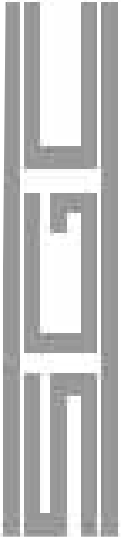

If your family or business needs to talk with you while you are at sea, they can reach you via the High Seas operator. They must dial "0" and ask for the High Seas operator. Then they must give the name and call sign of your boat, your approximate locations, and the times and channels that you normally monitor.

You can receive an incoming call only when your transceiver is turned on and tuned to a High Seas coast station channel scheduled for a traffic list broadcast. The traffic list will not be broadcast on any channel that is busy with traffic at the scheduled time. The same list is sent from all three AT&T stations on several frequencies. This will enable you to find a suitable channel to monitor broadcasts. Traffic list calls to each vessel will be repeated until you answer, or until the calling party cancels the call. Ships may be removed from the traffic list after 24 hours if up and there is no response. You may also call one of the radio stations to check to see if they are holding traffic for your vessel. This should be done during the non-busy periods. Peak periods occur at midmorning, midafternoon, and early evening. When you hear your vessel name and call sign on a traffic list, call into one of the stations and advise that you are responding to a traffic list.

In an emergency, it is possible to call a High Seas coast station who will alert the U.S. Coast Guard by land line. The U.S. Coast Guard can then establish direct contact with your vessel. They will use one of the High Seas ship-to-ship channels if you do not have the Coast Guard High Seas channels installed into your radiotelephones. They will stop all traffic in progress and immediately patch you through to the Coast Guard. All High Seas operators are trained to handle emergencies and these telephone stations don't charge for public safety communications.

AT&T publishes a free Fingertip Guide for High Seas radiotelephone service. This guide is a comprehensive overview of their service and use of marine communications.

On an overseas voyage, you might not be particularly interested in placing phone calls. However, if suitable channels are installed in your set, the nearest shore station can be contacted for assistance in an emergency.

When calling the shore station, make your transmission at least 15 seconds long. Some stations use a voice-actuated switch with a long time delay to eliminate false calls.

When calling another boat, select a ship-to-shore frequency on the band that you want. Then call the other boat by their name and call sign, and wait for a response. It's a good idea to have a schedule if you plan to call other boats; the radio operator on one boat can call while the other listens. This coordination will avoid unwanted interference to other users.

When signing off, name the other boat, your boat and call sign, then "out." Enter all communications in the radio logbook.

SHIP-TO-SHIP CALLS

Safety at sea is the mariner's principal concern. Obviously, a distress signal gets precedence over all other traffic. It is the boat owner's absolute responsibility under FCC and international regulations to adhere to rules governing safety communications; to notify the U.S. Coast Guard immediately when emergencies arise and to classify the call in the correct category.

EMERGENCY CALLS

If you are in distress, you may use any means available to attract attention in order to obtain assistance. You are not limited to the use of marine radiotelephone distress frequencies. Often, visual signals, including flags, flares, lights, smoke, etc., or audible signals (such as your boat's horn or siren, a whistle or megaphone) will get attention and help you need.

You should contact the Coast Guard in any emergency situation you are experiencing that requires assistance. You should also contact them to report an emergency on behalf of someone else, to report severe weather conditions that could affect safety at sea, or to report maritime crime.

Contact the local Coast Guard on 2182 KHz or on one of the High Seas Coast Guard channels, by calling out their name, then identifying your vessel's name, call sign, and location. The Coast Guard will return your call and instruct you to switch to a 2 MHz simplex working frequency or to a working channel in the HF spectrum. However, you are not limited to the use of these channels; you may use any other frequency that is available to you.

Three priority calls always take precedence over general communications (categorized by priority):

- 1. *Mayday*** This distress signal identifies messages that pertain to boats or persons that are threatened by immediate danger of loss of life or property.
- 2. *Pan*** This urgency signal identifies messages that pertain to vessels or persons in jeopardy, including "man overboard."
- 3. *Security*** This safety signal identifies messages that pertain to navigational hazards or emergency weather warnings.

SG-2000 has 2182 at the push of a button

If you hear any of these calls, discontinue transmissions and listen carefully. Log the call sign and name of the vessel and the information that is being transmitted. Give the Coast Guard time to respond, but if you hear no reply to the Mayday, Pan, or Security call, you are responsible to answer the craft. Use your own radio to relay the

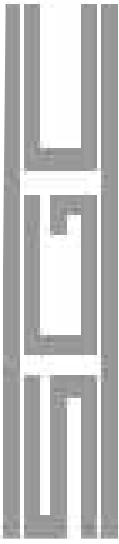

distress or emergency call to the Coast Guard. You are required by law to stay on the frequency and give aid if it is called for.

An emergency endangers life and property at sea. The Mayday call is only made in true emergencies, and false distress calls are punishable.

If you have an emergency at sea and need to make a Mayday call, choose 2182 KHz (the international call and distress frequency) and say "Mayday Mayday Mayday." Give the name and call sign of your vessel three times. Give your location and a brief description of your emergency, the number of persons on board, and if anyone is injured. Describe your vessel and say the boat registration number. Speak slowly and clearly. Finish by saying the name of your vessel again and end with "over." If someone does not answer within moments, repeat the entire message again and again, and pause to listen between the messages. If no station responds on 2182, use one of the high-frequency Coast Guard channels. If you don't receive a response on these channels, use the High Seas telephone stations. Do not wait for a clear channel, but break in on any channel where you hear traffic; give the Mayday information again, as soon as possible.



An alarm generator gets attention in an emergency situation. This option can be installed on most HF SSB equipment and the two-tone signal sounds very much like a European police siren. To activate it, switch to the alarm position and press the start button. The auto stop feature is particularly valuable during an emergency so that the skipper of the vessel can attend other pressing matters or collect information to be transmitted and not have to manually attend the radio for 45 seconds.

CHAPTER 7

**SGC'S VISION OF
SMART PRODUCTS**

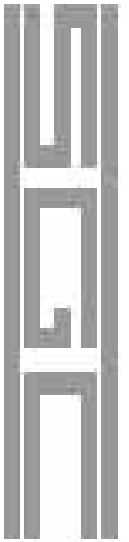

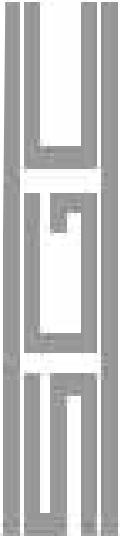

THE HISTORY OF SGC

Let's begin with a brief history of the Company. SGC was formed about 25 years ago by Don Stoner and Pierre Goral. Both of these men brought extensive experience in design and construction of radio equipment. Don was known for his many publications in the field of ham radio and Pierre had become something of a legend in South America and the leading expert in getting top performance out of HF systems.

The company was originally called Stoner-Goral Communications, but was soon shortened to SGC. Today, Goral continues the company and Stoner has become semi-retired and is pursuing the advancement of ham radio.

The rest of the pertinent information about the company is pretty much contained in our company history - "The SSB People" (available upon request), except to note that the company is privately held and that financial information is not public. The company has no debt and more than 70% of its product is exported to countries outside of the U.S.

**SGC has been
designing
communication
equipment for
25 years.**

This is why the company has been around for 25 years. It is a matter of conservative financial management and solidly designed product coupled with a commitment to provide the highest quality SSB radio equipment which is available anywhere.



SGC PRODUCT LINE

The SGC Power Tool product line brochures, outline some of the products which the company sells. As you will see, every component necessary to put a high performance SSB voice or data station on the air is included in our product line.



This means if you come to SGC with an antenna problem, we have a solution that not only works, but has been optimized for the kinds of conditions which you are likely to encounter. Similarly, if you need assistance selecting a transceiver for your application, we have the right choices. Of course there are antennas, mobile accessories, power supplies - ranging from the conventional AC mains to solar power cells and hand cranks, plus our wide assortment of data communications options.

Some people know, from seeing our equipment in places like the Army Communications Center at Ft. Monmouth, New Jersey and in Operation Desert Storm, that we do more than simply provide what is listed on the product line flyer. Although we are primarily a manufacturer, we also have extensive system design and configuration capability. If you have a unique need, we can - and have - taken our clients to the next level of communications. This means special para-military services, adaptive HF controllers and automatic linking - all part of the total service which we offer our clients; well beyond the domain of our public commercial, marine and amateur products.

THE SGC VISION OF HF

SGC views that HF offers many attributes which no other system now available will ever be able to provide. HF continues to be the premier way to get radio traffic moved quickly with high information density on a reliable basis without relying on vulnerable systems such as satellites and repeaters.

Although we have seen some encroachment from other technologies, such as satellite telephone systems, there are several advantages that HF offers which no one can touch. There is no recurring channel charge with HF. There are no massive towers and generators for repeaters and there is no defending real estate to keep a domestic radio system operational with HF. In the mobile radio setting, a tactical HF station represents a moving target - one which has both high survivability and low initial cost in addition to the assets previously mentioned.

So with all this in mind, we looked at HF products in the market, including our own, and came up with a

**The future of HF
communications is
with computer
technology.**

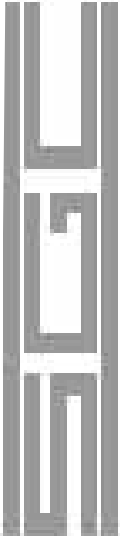

simple question, "How can HF be improved? The answer was really simple when you stop and think about it: put computer technology into HF equipment!

With the new vision came the realization that the ideal HF radio system would harness computer processing power from the antenna right through the radio itself. That has turned out to be the genesis of the company's strategic plan. We possess a clear vision not only of what kind of intelligence microprocessors should bring to the radio, but also how to reduce operator intervention and further improve the quality of communications. Thus was born the "SmartProducts™" from SGC!

As a crow flies, we are less than 10 miles from Microsoft and Boeing. SGC's geographical position has given us access, both on a retained and consulting basis, to some of the most educated and influential computer experts in the world. And, our combined backgrounds in commercial, para-military, aviation and amateur radio enables us to design multi-mission radios which are forward compatible with anything new.

The key is to remember where SGC is going: Putting computer intelligence into previously discreet and manually operated units. Designing systems which are automatic linking capable so you don't really have to twiddle dials to communicate between New York from Los Angeles, and embracing "BrainPower" technology.

We think you'll agree that we have a vision which goes far beyond putting another knob on a radio. We have completely rethought HF radio technology and all of its functions from the ground up.

MARKETING PLANS

Our product goal is to design multi-mission radios which offer superior performance for all applications. Our marketing goal is very similar - that is, to sell communications products across market boundaries. Some of our competitors have chopped up the market into 3 or 4 segments in order to get the most money out of those markets.

SGC designs multi-mission radios.

They would suggest that there is something mysterious and special about a marine radio or a ham radio or a military or avionics radio, and and that the boater should only buy a marine radio, and the ham operator can only use amateur gear designed for his market.

SGC states that this is simply not the case. In any communications use, the receiver still needs to be sensitive, the power output clean and reliable and the stability, IF filter slopes and other specifications need to be tight. So why are other people trying to sell you three radios instead of one?

SGC's philosophy is to design, manufacture and sell communications products with all markets in mind. You will never be limited to any one application with an SGC product.

THE EXPORT PICTURE



Nearly 70% of what SGC manufactures goes to other countries - from the smallest inter-village communications system with solar cells to highly sophisticated manpacks and computer network controlled systems of allied forces and large oil companies. SGC has been one of the leaders in providing reliable HF SSB communications around the world.

Our many years of manufacturing experience have taught us the value of absolute reliability and of the importance of easy repairability in the field. Such philosophies as designing in a 10 conductor control cable between our radios and remote heads rather than a fiber optic cable is one example. SGC has learned that while fiber optics are an excellent material, they are not easily repairable in the middle of the desert or ocean. SGC products are designed for field repair and performance where well engineered products dramatically become evident.

In addition, your feedback is extremely helpful to us - enabling us to keep up with the ever-changing world of HF communications. So while browsing through our HF SSB User's Guide, please feel free to contact us at any time with your comments, criticisms or ideas. Your feedback encourages us to maintain a valuable HF communications resource for you.

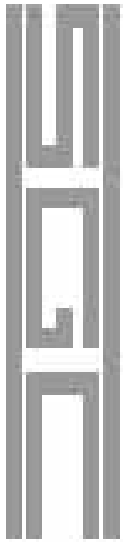

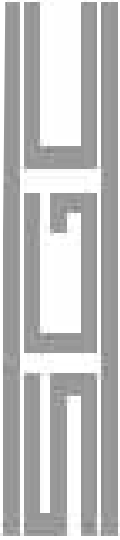

THE SG-2000 HF TRANSCEIVER

The SG-2000 is a radio which is designed to be a multi-mission radio. It is equally at home on a sea-going tugboat which has some of the highest vibrations you'll find anywhere, a ham shack, or an APC (Armored Personnel Carrier) in contested territory.

The SG-2000 HF SSB is at home on a United Nations jeep or in a ham shack.

This radio has incredible stability and absolutely the best engineering money can buy. The variety of head options allow the user to take advantage of several different features and customize his particular requirements.

The commercial niches of the radio include expeditions, geophysical survey groups which use the radio in key down data modes for months on end and for simple point-to-point telephone communications. The SG-2000 may be entirely controlled by a telephone line, so that comes into play in many commercial applications.

The military niche is that we offer the lowest cost adaptive controller compatible radio system available.

One example of how conservative our engineering of the SG-2000 is comes from the Civil Aviation Department of a small Southeast Asian nation. As you may know the control head of the SG-2000 may be removed and mounted remotely. We specify that the control head for the radio unit can be placed up to 50 meters from the radio, which is about 165 feet.

This country doesn't have a tremendous budget, so they tried to see what the cheapest route would be to make the control head work at 1.5 kilometers - that's almost a mile (or 5000 ft) down the road from a control tower. And do you know what they found?

The radio control head, simply hooked up to 5 plain old pairs of phone lines *worked*. This is system integrity worth talking about. To say we build brick "out houses" may over state things, but remember that an SG-2000, with our Smartuner™ and SG-303 antenna just crossed the North Atlantic on a paddle powered boat, which put Dwight Collins and I guess SGC into the record books for the longest paddle powered expedition ever.

So let's turn to the radio itself:

It has the largest Liquid Crystal Display (LCD) which you will find anywhere. Many of our marine clients want to look across 20 feet of deck on a cloudy day in a 20 foot sea and know what the radio is doing. It's very visible. And, if you are driving, you don't have to look away from the traffic for more than a split second to know what frequency you are on. About the only better approach would be a heads up display and we're working on that for some of our special forces clients.

The SG-2000 has one of the largest displays (LCD) on the market.

The front panel is splash resistant, but we don't recommend submerging in green water!

Up to 8 remote heads can be used with the SG-2000 series of radiotelephones.

The biggest single feature of the SG-2000 is the multiple head capability and the various heads to choose from. You see, the head comes off this radio and you can place it up to 50 meters from the radio and you can hang up to 8 of these heads on a single radio, have intercom between all of them and also have complete computer control.

Operator style will be different with the SG-2000. The radio demands that you have an operator who knows where he or she wants to operate. The frequency entry sequence is very simple, you simply press Program, Frequency, enter the numbers and press program. That radio is now on the new frequency.

You may recall up to 750 channels from the memory of the radio which is nothing short of massive. To recall a frequency from memory you press channel twice, and enter the channel number followed by channel again.

Scanning is either by frequency, using any combination of 6 scan banks in the radio (each one holds up to 10 channels) or frequency scanning, which picks a frequency and then tunes up or down.

There are some other important variables in operation which you will not see on any other radio for a long time: namely, scan speed and frequency step. This allows you to spend a fraction of a second or considerably longer on each channel or on each scan step. Or, you can move the receiver in various sweep speeds from 100 Hz to 5 KHz at a time. There were a lot of engineering reasons why we did some of these things, but the biggest reason was that to be forward compatible with adaptive controllers, variable scan speeds - or what the engineers call dwell times - must be available.

Yes, the front panel can be locked, there is CW with sidetone, the radio is data controller ready, and there is a true AM detector for the radio listener. Beyond this, the radio has the kind of specs which you would expect in receiver sensitivity and in transmitter performance, except we should mention that the transmitter has four power transistors in the final amplifier section instead of two. This was a reliability decision.

The control heads are on their own local area network. This was done to keep things organized and to insure that we would have a platform which would meet future expansion requirements and which would provide good

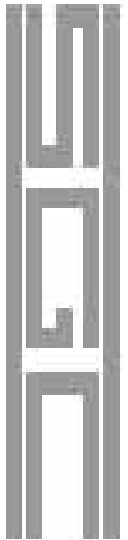

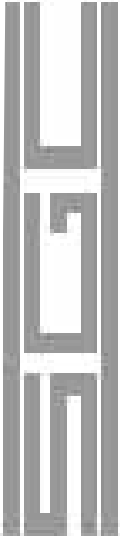

access to all functions of the radio.

The optional RS-232 interface allows for complete computer control of all radio functions except audio. This means that if you want to put an SG-2000 up on a mountain top somewhere and access it by telephone lines, you simply put a computer next to the radio with two serial ports. One of the computer serial ports addresses the radio while the other is used for a modem. We recommend Norton's pcAnywhere because it not only lets you control the

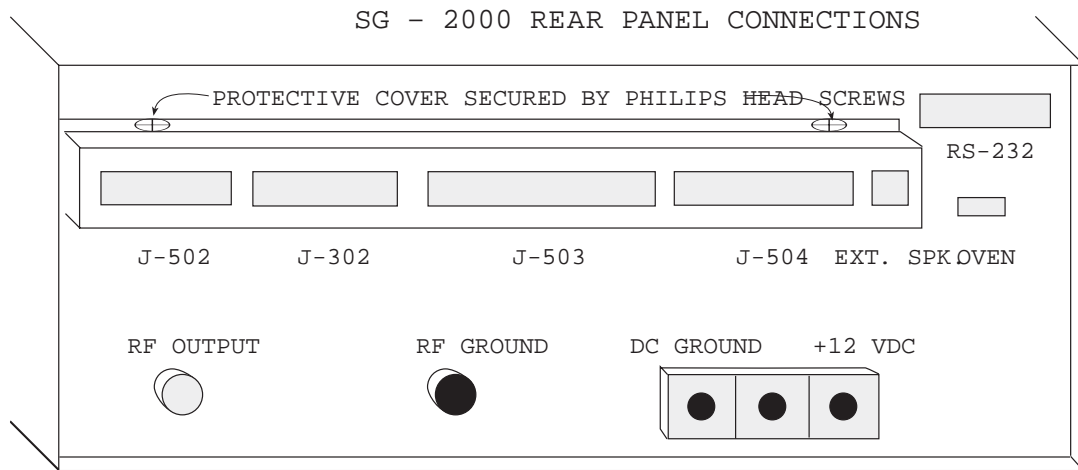

radio but has good file handling capability for computer-computer transfers.

There are some heavy duty options that are worth pointing out: There is a high capacity cooling fan kit which allows for continuous operation. There are also options which civilian clients may not use, such as the shock mounting tray and the waterproof military type handset.

You can change bands while the unit is scanning in the frequency mode by first recalling a channel (a frequency of a certain band). Cross band operation is also supported.

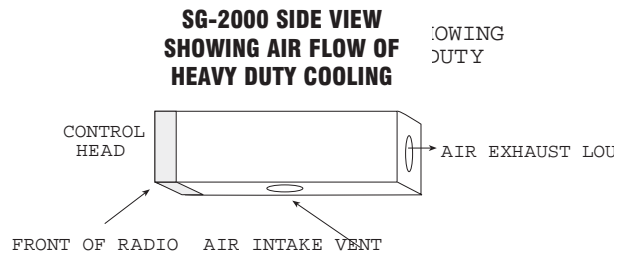

THE SG-2000: A NEW STYLE OF OPERATION

The direct entry VFO allows you to program in any frequency which you want directly from the keypad. You also have the option of making small frequency excursions by pressing the frequency button and using the up or down arrows to move around. If you hold the arrow keys in, the unit starts moving quickly, or you can just touch the key once and you will move one step at a time.

Remember that the step is adjustable to suit your operating style. Most people are quite pleased with the .5 KHz step, but when you are operating CW or running phone patch traffic, the 100 Hz steps are more appropriate. For Short-wave Listening, or to quickly check out activity on a band, the 3 and 5 KHz steps are preferred.

There are six scan banks in the SG-2000 of up to 10 channels each. This means that you can plug in any 60 channels of the 750 in the radio and scan these in any sequence desired. If you are a serious mariner, this means putting KMI channels in one scan bank, WOM in another and so forth. For hams, it means putting in band edges and sweeping the bands or perhaps many favorite operating frequencies.

You can also set up the scan banks so that you have different banks for different operating needs. You may have morning and evening frequencies, short-wave stations and time standards, or by language and by country. This is a matter of personal choice when setting up the radio.

The amount of time the radio spends on each channel before doing the next frequency change is something we refer to as dwell time. This is adjustable from the front panel as well. For most normal operations we recommend speed 3.

Someone asked us in a training session not long ago if this means the radio can be set up to do frequency hopping for the military. We would prefer not to go into specifics on that type of question except to say that this is a computer controlled radio which will work with adaptive controllers if desired.

Not only does the radio scan from memory, it also scans by frequency. You can start at 2 MHz and scan up or down from that point. Again, remember that the steps are adjustable from 100 Hz up to 5 KHz which gives tremendous flexibility. The .5 KHz step rate will give you 6 chances to hear something on each 3 KHz voice channel.

**Channel capacity is huge
- up to 750 factory
programmed and user
programmable!**

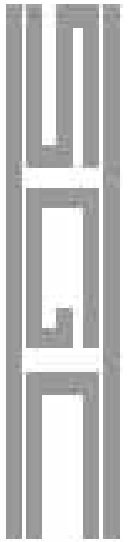

SGC SG-2000 POWERTALK™

The PowerTalk™
uses ADSP™ and
SNS™ technology.

Presently, the equipment that best uses the available DSP filtering technology is the SG-2000 PowerTalk™. Likewise, the Watkins-Johnson digital receiver does incorporate digital filter design extensively, but some of the helpful DSP features are not included. The SG-2000 offers the most DSP features for the lowest price.



Some of the key DSP-related features of the SG-2000 PowerTalk™ are:

- * ADSP™ noise-reduction system
- * SNS™ noise-reduction system
- * First mobile/base HF transceiver with DSP
- * First HF DSP system with visual display
- * DSP filters can be programmed into separate memories
- * Contains a notch filter
- * Contains eight preset DSP filter positions
- * Only transceiver with variable high-pass, low-pass, and bandpass IF filters.
- * Separate control head makes upgrade from SG-2000 to SG-2000 PowerTalk™ simple and much less expensive

ADSP™ NOISE REDUCTION

ADSP™ (Adaptive Digital Signal Processing) is a particularly effective type of noise-reduction system to filter out unwanted noise in any signal that is being received. The DSP algorithm is "smart" and can "see" the difference between the signal being received and the accompanying white noise and static crashes. Then, it separates the two and only passes the received signal to the speaker.

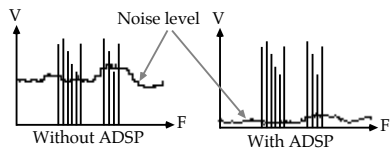

ADSP™

Noise level is substantially reduced.

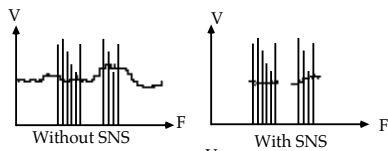

SNS™

The noise of the unused bands of frequencies are totally subtracted.

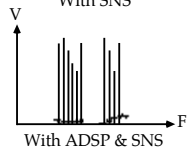

ADSP™ & SNS™

The combination of ADSP & SNS further reduces the noise level.

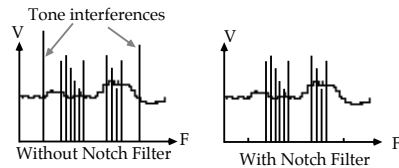

NOTCH FILTER

Interfering tones are suppressed by 40dB and up to five tones can be notched out simultaneously.

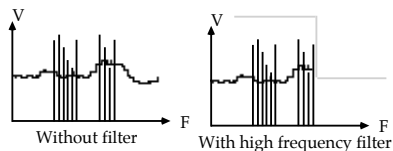

HIGH FREQUENCY FILTER

High frequency corner can be adjusted in 100Hz steps.

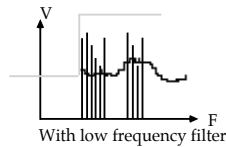

LOW FREQUENCY FILTER

Low frequency corner can be adjusted in 100Hz steps.

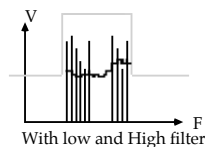

CENTER FREQUENCY FILTER

Bandpass center frequency can be adjusted in 100Hz steps.

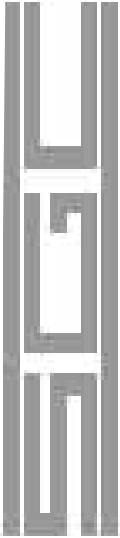

SNS™ NOISE REDUCTION

SNS™ (Spectral Noise Subtraction) is a revolutionary type of DSP noise reduction that is only used in the SG-2000 PowerTalk™ and in the PowerTalk™ stand-alone. Instead of the traditional method of filtering whereby signals are passed through a bandpass filter with a concrete shape, the SNS™ system acts more like a continuously variable bandpass filter. With SNS™ noise reduction, the filter basically collapses against the radio signal (either voice or data). As a result, the radio audio (and any interference during that audio) remains, but the noise between the bits of audio information is eliminated.

FIRST MOBILE DSP TRANSCEIVER

Unlike other DSP transceivers, the SG-2000 PowerTalk™ is small (4.75" x 10" x 15"), light (12 lbs), and made specifically for 12-volt operation (the IC-775 DSP, for example, is twice this size and three times the weight with no 12-V capabilities). On the road, on a boat, or on a DXpedition, where the conditions are much less than ideal, you will really notice the benefits of the size and DSP functions.

VISUAL DSP FILTER DISPLAY

In a few cases, competing adjustable filters are controlled with rotary knobs with the increments marked around them. But with the SG-2000 PowerTalk™, the filter positions (from 300 to 3000 Hz) are adjustable (in 100 Hz steps) and each step is displayed as an LED on the front panel. With this LED display system, you can immediately see the width and the exact frequency coverage of the filter that you are using at any given time. This system is particularly useful if you need to dial between many different frequencies and the signals are of varying strengths and characteristics.

PROGRAMMABLE DIGITAL FILTERS

You might contact a station on a regular basis, and you might find that a certain filter setting works very well for listening to that station, day after day. For your convenience, you can preset this filter setting into the radio memories (along with six other favorite filter settings). With a push of a button, you can immediately have the SG-2000 PowerTalk™ in your favorite filter position.

PRE-PROGRAMMED FILTER SETTINGS

In addition to the seven programmable filter settings that you can create, eight standard settings are pre-programmed into the memories. These positions are some of the most common and they are marked with LEDs for extra convenience.

NOTCH FILTER

The notch filter can locate and eliminate as many as five heterodynes at one time--many more than you will probably ever need to use!

VARIABLE BANDPASS, LOW-PASS, AND HIGH-PASS FILTERS

The SG-2000 PowerTalk™ is the only transceiver with variable bandpass, low-pass, and high-pass filters. The filters are one of the keys to good radio reception. The accurate display and excellent variable filters could easily make the difference between a copy-able signal and an unreadable signal in the noise.

UPGRADE DSP HEAD

Instead of being forced to buy a new transceiver for the DSP functions, you can just purchase the SG-2000 PowerTalk™ head and place it on the SG-2000 transceiver box. Doing so could save you time and money if you are already one of the thousands of current SG-2000 owners.

In addition to the DSP advantages of the SG-2000 PowerTalk™, this model also has a number of other advantages.

REMOVABLE HEAD

Unlike other HF transceivers, the entire faceplate ("head") of the SG-2000 can be removed and used to operate the transceiver from remote locations or in tandem with other heads. This amazing development is perfect for commercial and marine operation, or for club amateur stations, where a transceiver might be controlled from more than one location.

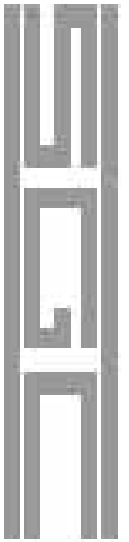



SIMPLE DESIGN OF FRONT-PANEL CONTROLS

Instead of cramming dozens of tiny knobs and buttons on the front panel of the SG-2000 PowerTalk™, only three knobs and a few rows of buttons are used. This is not to say that the PowerTalk™ is lacking in features, but rather that it is so well designed that fewer buttons were necessary to accomplish the same functions. Even the DSP section of the PowerTalk™, which features custom DSP memories, pre-programmed filter memories, a notch filter, a noise reducer, the SNS noise reducer, variable low-pass, high-pass, and bandpass filters, and a bypass function, only requires nine buttons. Because the panel has been simplified, the buttons are large and spaced widely apart--there's very little chance that you will mis-program the PowerTalk™ head.

BIG-POWER/SMALL PACKAGE

In spite of having the most flexible and highly developed DSP unit in any transceiver and being one of the highest-powered transceivers available (conservatively rated at 150 watts--the stress power is 275 watts), the SG-2000 is very small. As mentioned earlier, the SG-2000 PowerTalk™ is a mere 4.74" x 10" x 15", 12 pounds. You get everything in a package that you can take anywhere.

TESTED FOR HIGH QUALITY

No other transceivers advertise their testing procedures but at SGC, we're proud of our commitment to quality assurance. So, after it has been manufactured in the United States using high-quality components, every SG-2000 is factory aligned. Then, each rig is keyed down at full power into an open antenna for 10 seconds, then into a shorted antenna for another 10 seconds. Next, it is keyed down for 24 straight hours in full-power CW. Each SG-2000 is then keyed on and off at 10-second intervals for 24 hours. Finally, each SG-2000 is re-evaluated and all control functions are verified to ensure that the microprocessor is up to specifications. After the SG-2000 passes these difficult tests, it is ready to leave the factory. As a result of this quality, the SG-2000 is one of the few amateur transceivers that is also type-accepted for commercial and marine service.

The bottom line is that the SG-2000 and the SG-2000 PowerTalk™ are one of the best-constructed, most flexible, most advanced, highest-powered, and easiest-to-use transceivers on the market.

SG-2000 FEATURES AND BENEFITS

The radio is U.S. F.C.C. type approved which results in two benefits. First is that the radio can be used in commercial and marine service without running the risk of fines for illegal operation. Second is that this assures the buyer that the radio is rugged and does meet some good design standards laid out by the government.

The unit is American Made. This is the country which invented single sideband technology and SGC has been a world leader in SSB design for more than 20 years. Because of our long history with the product and the technology, we are able to offer superior design and reliability.

An SG-2000 has full performance ratings at 30 MHz. We achieve this by using four transistors in the final amplifier section and running them well below their ultimate capacity. This means long life and reliability of operation.

The radio supports up to 8 control heads. While the average user will ask for only one, the option is available to expand as operating requirements change. The standard SG-2000 control head features control buttons which are large, illuminated and big, for high visibility. All programming and command functions are designed to be as instinctive and user friendly as possible. The front panel is fully programmable for all HF SSB and ham frequencies and can be used to program other SGC control heads. Because the head is removable from the body of the radio, more graceful installations are also possible. The same microprocessors which set up the head control also provide the RS-232 access to the radio for remote control. The head network is, by the way, RS-422.

SGC believes that a control head should be perfectly matched to the job. So, in addition to the standard SG-2000 control head, we offer many remote head choices for this unit. SGC builds a product which suits multiple HF markets, and below is an overview of these head options:

a) The basic mobile head, Model SG-RM is perfect for vehicles where control head space is limited, and designed for inexperienced operators.

The head can be field programmed with either the standard SG-2000 head or via a PC based computer with appropriate software.

b) The SG-2000 got its' wings, and now has an aviation head specially designed for easy aircraft instrument panel installations.

**PowerTalk™ is
the only mobile
unit with built in
ADSP™ & SNS™**

This head option is offered for voluntary aviation fittings, and like the remote head, can be programmed via the standard SG-2000 head or via a PC based computer and appropriate software.

c) An SGC exclusive, ADSP™ and SNS™ are an amazing leap into all of the advantages of the digital HF SSB environment. SGC's PowerTalk™ 2000 head is ahead of its' time, increasing signal clarity and drastically

**All SGC products are
proudly designed and
manufactured in
America!**



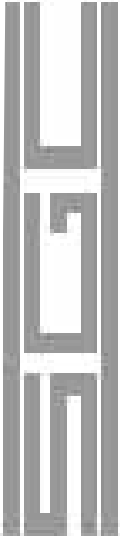

reducing noise. The PowerTalk™ 2000 provides unsurpassed signal quality on the HF bands. Red and green LED's provide precise visual tuning of high, low and center frequency cut-offs and a control knob gives you precise hands-on tuning capabilities.

d) The SG-RM XSEL remote mobile head has all of the standard features and specifications of the SG-RM, plus includes the Excel selective calling feature, which allows the operator selectivity when calling and monitoring frequencies.

e) Special order remote heads are also available from SGC. These heads are designed for special applications, depending on the user application. For information on our GMDSS and ALE remote heads, speak with the SGC sales team.

Complete telephone control of the radio is accomplished easily by phone lines and this is still another migration path which is open as user requirements change. Software to control the radio with an IBM PC/AT is included with the RS-232 option when ordered.

We haven't touched too much on the data handling capabilities of the radio but they are notable. We manufacture our own HF data controller for use with the radio using something called the ARQ/FEC/SELFECC mode. This translates to Automatic Re-transmit Query, Forward Error Correction and Selective Calling Forward Error Correction standards. Our system is compatible with the International standards laid out by the International Radio Consultative Committee, the CCIR in Geneva, Switzerland.

This product is called the TELEREX data system and can be used with radios other than the SG-2000. There is also a special version of the TELEREX system which is supplied to our continuous data clients which uses the 300 baud ASCII mode and no error correction for HF telemetry operation. If you happen to be an oil company, geophysical survey group, or a meteorological agency, we can go into substantial background and design assistance on this type of system.

The Slimpak is a slightly slimmer version of the SG-2000.

The SG-2000sp (Slimpak) radiotelephone features all of the power and refinement of the SG-2000 in a slightly slimmer form. The slimmer shape makes the Slimpak ideal for installations where

there is plenty of depth available but minimal height and width (like under the seat of your car or truck, in an aircraft dash or behind the console of your sports fisherman) and where space is at a premium. Electronically, the SG-2000sp is the same as the SG-2000, so the unit features the same 644 ITU and ham frequencies, 100 user programmable frequencies and weatherfax connections. Note also that the Slimpak is the 2000 electronic brain only, and you must choose one of the head options described above.





This is a fair overview of the SG-2000 except to mention a couple of ordering points which you should review.

First is that the radio is supplied with the control head attached (with the exception of the SG-2000sp Slimpak). The cheapest way to get the head off is to order the 16 foot extension kit with a "U" bracket (SGC Part Number 04-12). We also have a five-way mount, available with suction cups if desired, which allows control heads to be moved from vehicle to vehicle in a matter of moments (Part Number 04-14).

The RS-232 option is simplest ordered at the time of original purchase and we recommend this option for everyone. It is an addition to your HF system which will insure the highest resale value and provide future flexibility.

A mounting tray and microphone are included with the radio. Unless you are in a severe environment, you will not need the shock tray as the radio itself is capable of a lot of shock as supplied.

Remember, the standard microphone is a fist type microphone and a telephone type handset, desk mic, or the waterproof military type handset may be useful under certain conditions.

Finally, don't go cheap on the power supply. We often have people ask why we put out a \$700 power supply. Well, the answer is simple: The performance of the radio is related to the power supply. This is a radio which has a stress power output of 225 watts and more on some frequencies in the CW mode.

This means that some very high currents are involved. So from a professional standpoint, a big power supply is necessary to keep up with the radio and maintain conservative ratings. It is also why we supply optional power cables of 12 and 25 feet using number 6 wire. Anything lighter is subject to voltage drops.

QMS™ (QUICK MOUNT SYSTEM)

The QMS™ is the SGC Quick Mounting {Antenna} System which was developed for one of our Special Forces clients. They had a need to quickly take our equipment from one vehicle to another. This is because the radio equipment was holding up much better than the vehicles.

The QMS dramatically increases the efficiency of an HF mobile installation.

So we came up with a unit which increases the efficiency of an HF installation dramatically in the mobile setting by putting the coupler outside of the vehicle, shielding it from a lot of ignition noise, keeping the wiring between the coupler and the antenna as short as possible while at the same time providing for solid mounting of an antenna system without punching any holes into a vehicle.

What this system does is provide foolproof installations of radio gear. The QMS system gives you the highest performance level possible for a given situation.

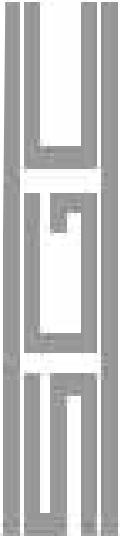

The unit mounts on a vehicle using a system of suction cups and high strength nylon webbing. Even at highway speeds, this provides a solid base for the unit.

One of the questions which we had when the QMS was introduced was the question of theft - and it deserves some consideration. What we have found is that the QMS doesn't get stolen, even when you leave it on a car in

Security is not a problem - the bad guys don't steal what they can't identify.

an urban area at night. This is because people don't have a clue what it is. In addition, the unit is labeled 'DANGER HIGH VOLTAGE' which may scare away some of the casual thieves.

The QMS system is available in three configurations: The basic box which has the hold down system is called simply QMS. QMS I is the QMS housing with an SG-230 Smartuner™

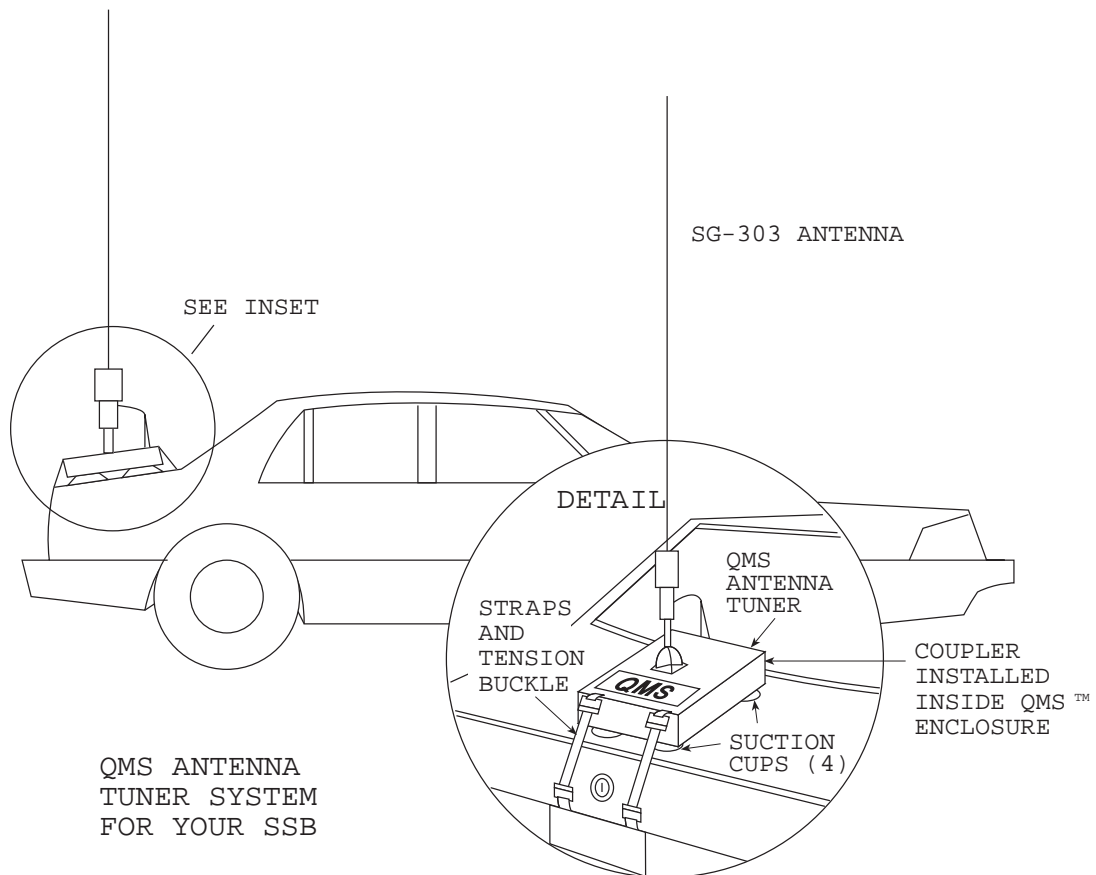

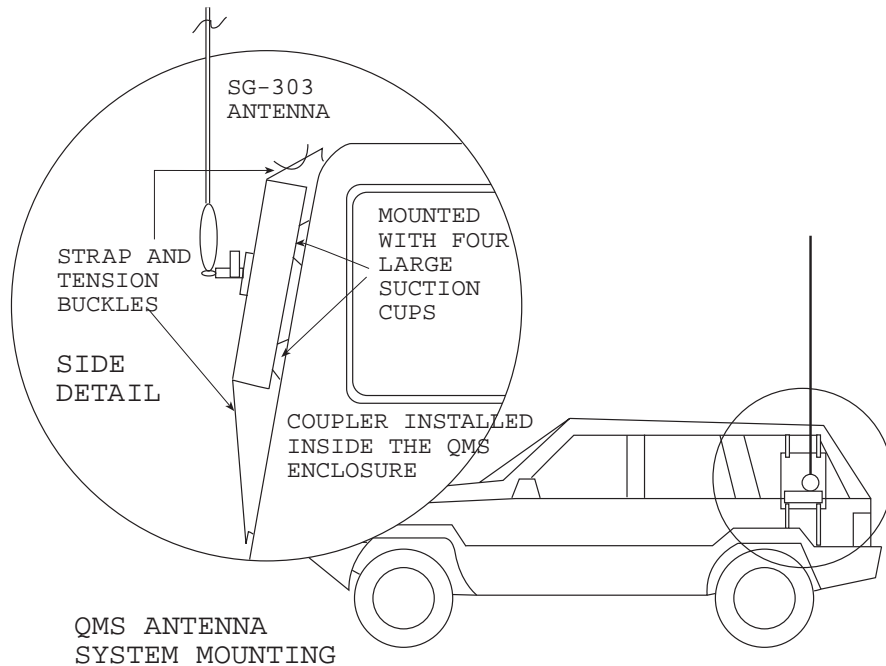

mounted inside and QMS II is the box, with a coupler inside and a high performance all frequency antenna, the SG-303 which we'll cover in a moment.

The real selling point of the QMS is that it will give increased frequency coverage and efficiency over a conventional installation and antenna system of the same height. This increased efficiency is due to a number of factors.

First, most antennas are so heavy that they are mounted on the bumper of a vehicle. This means that because of the location of the antenna, about a third of it is within a foot of the body sheet metal. This effectively shields radiation and causes the pattern to be less than omni-directional. So while on some lobes you will see a 6 dB drop in signal, other areas will experience a 3 dB loss.

Next is the mounting position of the antenna coupler. If you have a coupler mounted in the trunk of a vehicle, you will have 1 to 2 feet of HV cable going to the antenna on the outside. With as short as a 1 foot lead wire, and using a 9 foot antenna, this means that fully 10% of the antenna system is inside the vehicle where it won't transmit or receive worth a darn.

It also subjects the system to another 10 to 100 pico Farads of capacitance and depending on the frequency used, this can be a major factor in loss on the transmit side. Also, a coupler in the trunk is more subject to vehicle noise.

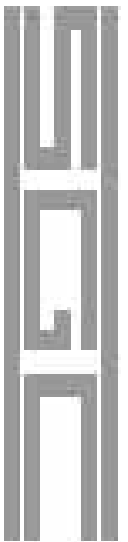

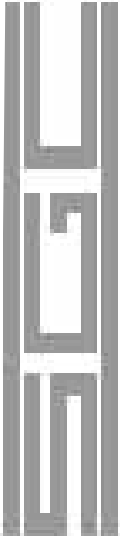

Then there is the wire size used in the antenna. You may not be aware of it, but almost all of the resonant type antennas which are sold are wound with number 22 wire. Our SG-303, which is the antenna of choice for the QMS, is not wound with wire, but is wound with 3 millimeter wide tape wire strap. This gives us the equivalent of number 4 wire. Now, when you run into high current load, those small wire sizes will result in a loss of 3 to 6 dB.

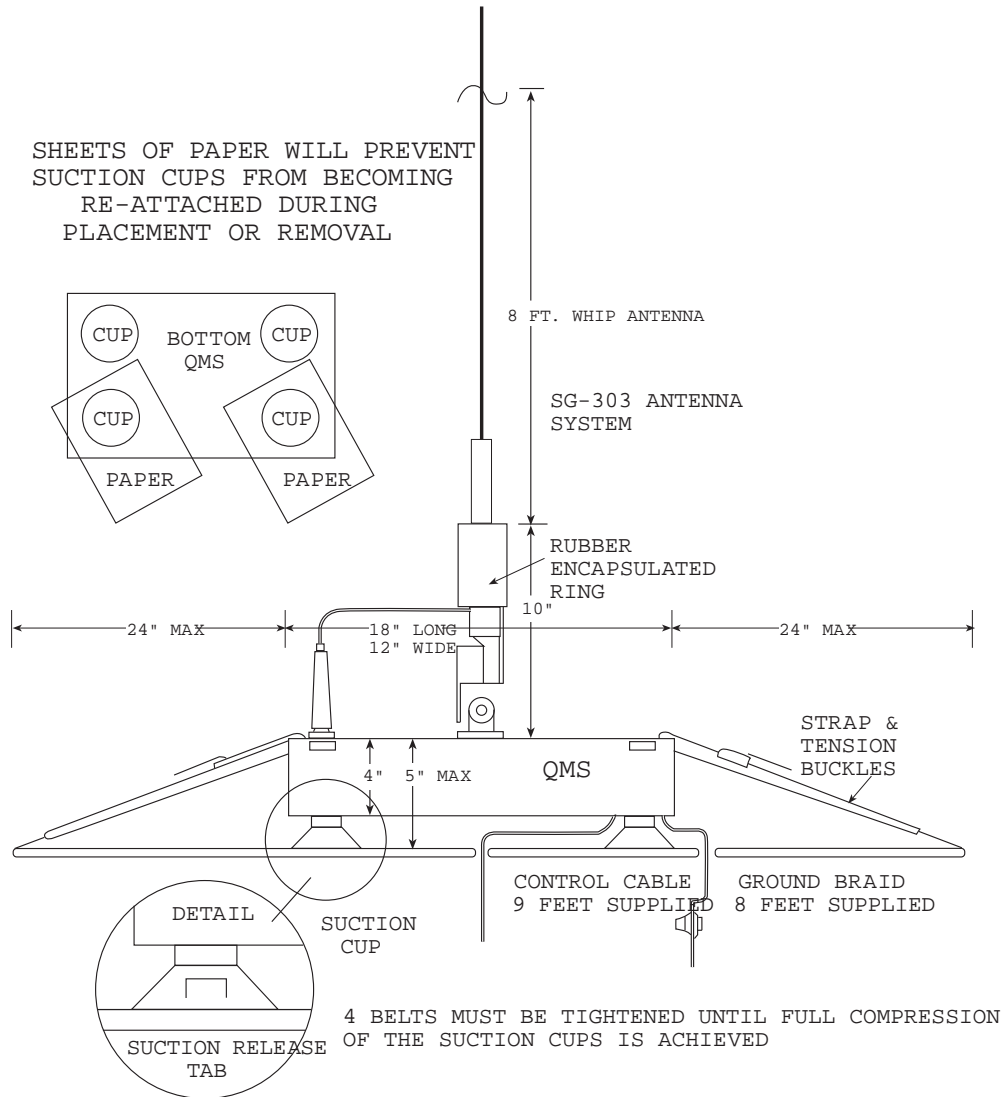

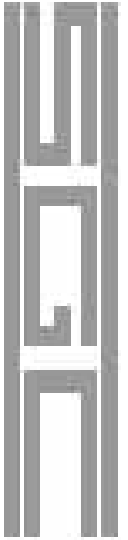

This is why when you are putting up a base station antenna you should use number 6 or larger wire because you will get tremendously improved performance.

The next consideration is how the antenna system works. With our SG-303, there are actually two antennas in a single casing. There is a single rod element, which is resonant at about 22 MHz, and there is the helical wound element which is resonant at about 13 MHz. This means that on lower frequencies, those under 20 MHz or so, the SG-303 will vastly outperform other antenna systems.

Even when the resonant type of antennas are used, the SG-303 will out perform because a lot of people don't understand that when you operate a radio system on a frequency higher than the resonant point of the center loading coil (which is the most common form of loaded antenna), the loading coil begins to act like an RF choke.

So if you set up a marine antenna for resonance in the 3 MHz band, then use the same element to operate at 8 or 12 MHz, the loading coil has just turned a typical 23 foot antenna into about a 5 foot antenna. And this principle applies to ham and commercial installations as well. When you use a center loaded low frequency antenna on 8 or 12 MHz, you end up with an effective antenna length of less than 2 feet!

When you add up all of those individual dB's and compare them between systems, what you will find is that there is a tremendous advantage for the QMS system. But when you hear a really big mobile signal, and we're talking marine, land or airborne, you can be pretty certain that either the coupler has been done right or the system is operating really close to resonance.

**Learn to love
the look!**

QMS FEATURES AND BENEFITS

As we mentioned a moment ago, there is no mounting hole for an antenna and no pass through hole for feed lines with the QMS when installed on a car. This means that the resale value of a vehicle is held intact.

The QMS houses the tuner which makes the lead from the antenna as short as possible. And by putting the tuner outside the body of a vehicle, you get the advantage of shielding from a large portion of internal vehicle noise. This is a major plus on the receive side.

The QMS may be removed and stored in 5 minutes or less, quickly hiding the fact that there is an HF radio in the vehicle. This quick removal feature is really useful when you are operating in contested frontier areas - or if

**The QMS mounts
with straps and
suction cups so
no holes need
be drilled in your
vehicle.**

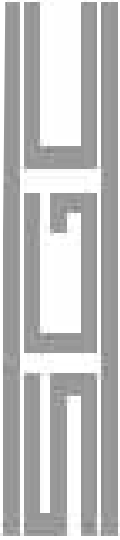

you are going into a part of an urban area where you don't want to draw attention to yourself and your equipment.

The suction cup and nylon webbing keeps the system secure. We have tested it to speeds over 100 MPH and the only thing that happens is that above 65 MPH or so, the SG-303 wind load begins to bend the antenna back a bit. You have 2,000 pound breaking strength nylon webbing which is not going to break unless you crash the vehicle and probably won't break, even then.

Best of all, the installation becomes foolproof. No matter who is doing the installation, the finished product, and that's the signal on the air, is going to be the same whether it is done as a weekend project, or if you hire an expert to do the work for you.



SG-230 SMARTUNER™

Having talked about how to mount an antenna in a mobile configuration, you are likely wondering about the role of the antenna coupler, the SG-230. Before we get into a lot of details about how the tuner works and why it is such a critical item to include in any well configured HF system, let's review the function of a coupler.

A lot of our customers use the terms "coupler" and "antenna tuner" interchangeably. This is technically

incorrect. The antenna tuner has come to mean the matching systems which are located inside of the radio while the antenna coupler is a matching device which is installed at the feed point of the antenna.



The difference in performance is large. The true antenna coupler will outperform the antenna tuner everywhere but at resonance and usually even there. This is because of two misunderstood concepts.

First, you must clearly envision what is going on with an antenna: Every piece of wire of any length has a resonant frequency. When people put up dipole antennas which are precisely measured, the antenna will have a resonant point which may be easily calculated. But if you've ever put up such an antenna, you know that you will invariably spend hours trimming the antenna to get a good 50 ohm match.

This is because the impedance of a dipole antenna is only 50 ohms in free space. But there is no such thing on the earth, so you have to come to terms with reality and in this case that reality is that the 50 ohm point and the resonant point can be far apart.

This is where a true coupler comes to play. By being mounted at the antenna feed point, the coupler provides for optimal matching of the antenna feed line and the impedance and resonance of the antenna. An internal trimmer type of tuner in a radio doesn't do anything more than make the best of a bad situation.

Realize when you look at the capabilities of the SG-230 Smartuner™ that you are really seeing one of the major building blocks of the "Smart Radios™" concept at SGC. The process of properly setting up an antenna coupler manually involves hours of trial and error to get the kind of results that this system gets instantly. As a radio professional, if someone said that they would give you a manual coupler and your job was to set it up to get better than 2 to 1 SWR from 1.8 to 30 MHz with no holes anywhere, we think you'd agree that would take hours if not days.

But with a Smartuner™ this is a snap! Tuning happens within seconds the first time a frequency is used. During this time the Smartuner™ is actually learning the conditions of the antenna at a given frequency. After that, the frequency is recalled from memory and tuning is just under instantaneous - it takes about 10 milliseconds.

**The Smartuner
automatically tunes
ANY antenna to
ANY radio!**

The SG-230 will match every transmitter from 10 to 150 watts to almost any antenna system. We have users who are using down spouts, gutters, flagpoles, railings around decks and some of the most absurd things to which you would consider applying RF. Yet they all work within some limitations which we should be clear on.

To begin with, a Smartuner™ may load it, but that doesn't mean it will "get out" like gangbusters. The down spout and gutter antennas do pretty well on the low bands, but they may not work as well on the higher bands. Also, the efficiency of these kind of antennas relates to the conductivity of the antenna element and quality of the ground system. The better the antenna ground conductivity, the better the signal.

We recommend the biggest ground you can get. In a sailboat or any other kind of vessel which doesn't have a metal hull, we recommend a series of copper straps down the chine line inside, a center strap down the keel line and all of this tied together at the engine or the keel. Even though the keel can be insulated from the sea by an insulating material such as paint or fiberglass, its large area will act as a large coupling capacitor. This ground, in turn, should be connected through a stainless steel stud through the hull to a dynaplate on the hull.

On the shore side, the most efficient system involves a series of radials of at least one quarter wave length at the lowest operating frequency. As an example, at 3.5 MHz, this would be about 66 feet. Obviously this takes some effort to install, but it is a highly efficient ground system, especially when laid out in a spoke-like manner around an antenna. AM broadcast stations virtually all use such radial ground systems around their towers.

As an alternative, a series of grounding rods, driven in about 6 feet apart and at least 6 feet in length will work,

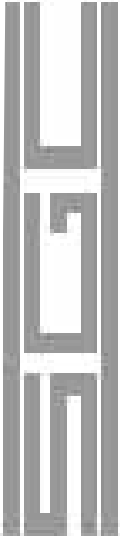

but not as efficiently. If you can't hit permanently moist soil (or even if you can) we recommend you supplement the rods with a good dose of copper sulfate or other soluble metallic salt to increase ground conductivity to the maximum extent practical.

If these systems are not available, a third, but less desirable choice would be to use a water pipe. Caution should be used in relying on a water pipe ground as in many municipalities, plastic water mains have been laid in recent years, which quickly diminishes the effectiveness of a water pipe ground system.

On vehicles and aircraft, we recommend tying all metal components together and using the largest possible antenna. We have found that wing tip to vertical stabilizer wires work well on light aircraft while trailing wires, loops used with the airframe forming part of the loop and shunt fed aircraft antennas work well on faster planes where vibration or icing conditions becomes an issue on long wires.

When RF is applied to the Smartuner™, a broad band receiver inside the coupler looks at the antenna and feed line conditions and calculates an ideal match. This may take several seconds the first time the Smartuner™ is used on a new frequency or antenna. But after this, the retuning becomes nearly instantaneous. The frequency and antenna settings have been written to a chip which stores more than 500 settings.

One thing which some people worry about is whether they should apply full power to the Smartuner™. Of course! No damage will be done to the tuner from applying full power for tuning. In fact, we recommend this procedure because there are many radios which incorporate an SWR protection circuit which reduces transmitter output when the SWR is too high. Using full power CW or whistling into the microphone on SSB will give maximum power and will speed tuning.

When you return to that frequency in a later operating session, the previous settings are instantly recalled. The chip which is used for memory, as you might have guessed, is a low power chip and is non-volatile capacitive storage.

Once the unit has recalled the settings, a monitoring process takes place, and retuning is ordered when the software calculates that a tuning improvement can be made.

One of the questions everyone asks is whether the 500 memory positions ever get filled up. The answer is "NO!" because they are over written. We have never come across an antenna system which will fill up all 500 memory channels outside the lab, but the write over has been tested and works well.

The broad matching range of the SG-230 is also something to behold. Back in the days of tube type transmitters, it was efficient to convert the high impedance tube output, which was typically in the 5,000 to 10,000 ohm range, to a fairly high antenna feed line impedance (200 to 800 ohms). This is why in the old days, ladder type feed lines were used.

With today's modern equipment, impedance's in the transmitter's amplifier stages are far lower (less than 50 ohms) and the loss which may be expected from the conversion

**The Smartuner
automatically
retunes the antenna
every time you
change frequency,
and then remembers
the setting for the
next time.**

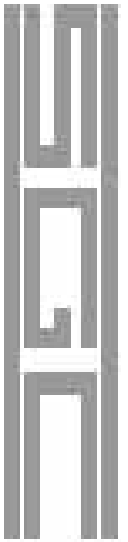

process in matching networks is smaller. The Smartuner™ has more than half a million combinations of inductance and capacitance from which it selects the proper values. The coupler can match from roughly half an ohm to 10,000 ohm impedance's.

We do want to note that while the specification says the Smartuner™ will match anything from 8 feet to 80 feet, it will only match 8 feet down to about 3.7 MHz, depending on the ground system. To use the lower frequencies, some loading, or a broad band antenna such as our SG-303 is required. As a piece of wire, you would need 23 feet at 2 MHz.

As a practical matter, the longer wire is highly desirable, as is using the largest possible diameter wire, because the longer antenna with a bigger conductor will be much more efficient at the lower frequencies. The higher the current on the antenna, the more important the wire size becomes.

At the other end of the HF radio spectrum people ask why 80 feet is the recommended limit. The answer is that while the Smartuner™ will do an excellent job of tuning a 350 foot wire, the radiation pattern becomes directive at several wavelengths. For this reason, we do not suggest extraordinarily long wires because you must use a better ground and you must understand that directivity will be encountered.

Finally, keep in mind that if you are using a good antenna and a poor ground system that things can get reversed: If the antenna is bigger electrically than the ground, the radiation effectively goes into the ground. This not only defeats the purpose of the coupler, but the radiation pattern is terrible.

SG-230 FEATURES AND BENEFITS



The most important part of the SG-230 is that it will match almost any antenna which comes along. This gives you tremendous flexibility in choice of antennas. When used at sea and in tactical situations, the benefit is that you can "jury rig" something together which, although it may not be elegant, will get the job done and facilitate communications.

The ease of tuning of the Smartuner™ is another key: It is a dynamic system which will automatically compensate for various changes in conditions. This makes it ideal for use by non-professionals and by people who may not have the ability to tune a conventional system. Sight impaired amateurs give us constant compliments on the ease of use.

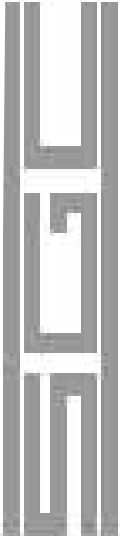

The wide frequency coverage is also a really important feature. There are a lot of antenna couplers on the market, but the Smartuner™ leads the pack when it comes to broad spectrum performance. The specification of 2 to 1 SWR (or better) isn't in one area of coverage, it is across the entire range over which the tuner operates.

The wide impedance matching capability makes the tuner ideal for experimental applications and antennas. A Smartuner™ doesn't care if you are running a long wire, a Windom, off-center fed wire or anything else that comes to mind because whether the impedance is 8 ohms or 800 ohms, the Smartuner's Microtune software and circuitry will come up with a proper solution every time.

Of particular note for boaters and people who will be using the unit outdoors is the waterproof construction. While the unit is waterproof, we do recommend keeping it out of direct sunlight and out of direct rain and ice conditions. These steps are not necessary but are part of good engineering design and are how you build really long lasting high performance installations.

We have hundreds of Smartuners living in the rigging of sailboats which are all over the world. They work extremely well afloat. But as a side note here, we have to remind you that on a sailboat, the best antenna is the back stay and not the triadic, although they will work fine as our many users aboard ketches and yawls will tell you.

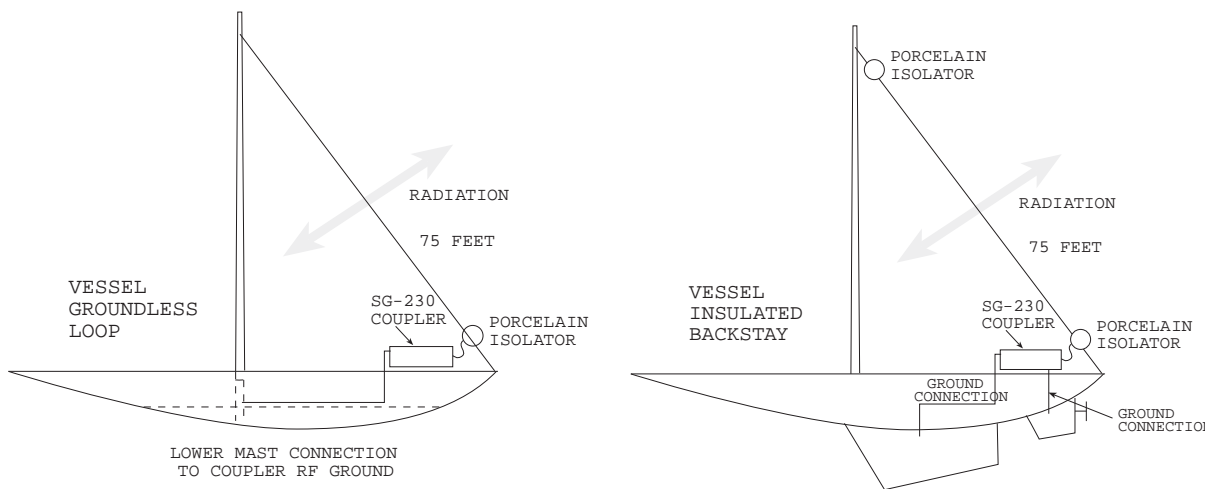

SG-303, SG-103 AND SG-104 ANTENNA SYSTEMS

We have a large number of antennas which we can provide, from the ultra compact antenna to the really very large log periodics which are designed for strictly large scale professional intercontinental systems.

The three antennas, though, which always generate the most interest is our SG-303 all frequency whip antenna for mobile and marine applications and our fixed installation broad band antennas, the SG-103 and SG-104.

Before explaining these in detail, most of which you can find on the detail sheets, we have to explain that there is nothing more important than using the right antenna system and the right ground to have a really big signal and reliably get through interference.

The right ground we have already touched on, as well as the size of element issue. But the point bears repeating: When you have a high current node on an antenna, there is no substitute for wire size. If you are using a high voltage antenna, such as the SG-103/104 design, it is not as critical. But when you get down into reduced size antennas, wire size is a "make it or break it" issue.

One comment that we hear frequently has to do with the cost of the SG-303. First of all, many competing mobile or boating antenna systems are less expensive because they do not use the top quality design and materials that go into each SGC product. This is also a case of "you get what you pay for."

The SG-303 is actually a dual element design.

To begin with, the antenna is a dual element design. The inner core of the 303 is a large diameter fiberglass rod. Around this is a layer of fiber composite which is custom made for us. We would have bought something a little more conventional, except that we haven't found anything else meeting our shatter resistance requirements.

Once we have the fiber composite on the large core antenna, we then wrap helical windings on the composite with 3 millimeter copper wire strap which is the equivalent of number 4 wire. We finish off the construction with a shrink wrap cover which is either white, international orange or matte black, depending on the kind of application.

A couple of examples are the 303's which are used on oil rigs and which always seem to have the radio shack located right next to the helipads. Another are the off-shore racing (power) boats which use the antenna. Plus we have the expeditions of several museums and societies which have come to rely on our products.

When Dwight Collins of Providence, R.I., recently rowed across the North Atlantic, the SG-303 was the antenna used for the record setting crossing. The 303 was selected because it was felt if the vessel rolled over in a cresting sea that the SG-303 would survive better than any other HF antenna available.

The dual element construction is a major cost factor that has a high reliability payoff. The fold-down ratchet is the most durable that we could find and the spring base is custom-made for us because we couldn't find a standard spring that would meet our specifications. The spring is molded in rubber to damp vibration and antenna movement at high speeds. The reason that our antenna will remain vertical at 60 MPH is that the spring has been specially

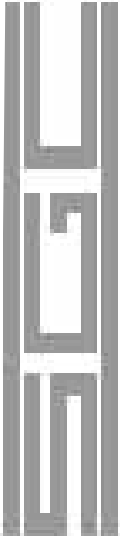

designed and tempered for this kind of service. If you mount an SG-303 on your Jeep, Land Rover or Humvee, you'll appreciate it's ability to take all kinds of abuse.

The most crucial element of the antenna is something we haven't mentioned yet: The base insulator.

As you can imagine, the SG-230 antenna coupler will put out a lot of RF. As a matter of fact, at the right kind of antenna condition, the SG-230 will put out more than 20 kV at 150 watts on some of the low bands with a highly loaded antenna. This is why you don't want to use an off the shelf type antenna for high performance work. The insulation will not hold up.

The insulation of the typical 102" stainless whip is in the range of 500 Volts. And we should mention that RF is a lot different when it comes to breakdown than is DC! We have all sorts of insulation related considerations to look at, including corona. At the kind of voltages which come with the SG-230, this is a design consideration. We use some exceptional insulation around the base of the 303 which is designed for both high insulation and a high leakage path.

If you are considering the SG-303, though, be clear that the antenna absolutely positively must use an antenna coupler. The SG-303 was designed solely to be used with the SG-230 antenna coupler and lesser couplers would likely not be able to handle the requirements of the antenna.

The SG-303 guarantee is a little unusual and bears some discussion. We have a standing offer to replace an SG-303 if you can break it in the first 5 years of service under normal conditions. And our idea of normal conditions is running around a desert in a Nissan Patrol or driving trucks around the Tundra or APC around a contested capitol. As a testament to the SG-303's durability, we haven't had to replace a single antenna!

**The rugged design
and full band
coverage provides
easy mobile use.**

SG-303 FEATURES & BENEFITS

First and foremost is the rugged construction. This is an antenna which will not break and it is rated to 70 MPH and as we have mentioned, we have a 100% replacement guarantee for 5 years.

The wide frequency coverage is something you will not find elsewhere. You get complete frequency agility with no wires to plug in, nor coils or hats to adjust. You simply pick your frequency, let your Smartuner™ learn the antenna conditions, and you are on the air with a great signal.

The dual element construction insures that you not only get great performance at 14 MHz and higher, but you also get great performance on the low bands where the helical element comes into its own.

The elements of the antenna are larger compared to what other manufacturers are using and for this reason, transmission losses are kept to a minimum.

Best of all, once you have installed an SG-303 you can basically forget about the antenna system because it will take care of itself. You can flip from one channel to another, from band to band and not worry about changing conditions in the rain and trying to find a spot to pull off the road to change resonators and go through another tune up procedure.

A Special Note for Mobile Operation:

You may want to consider a single frequency antenna in order to avoid the unnecessary cost of our flexible, multi-frequency system if you are planning to use your mobile HF radio gear on only one frequency, or one limited portion of one band.

For this reason, please plan to purchase an SG-303 only if you require multiple band operations. Single band operation can be done, although not to quite the same level, with lesser antennas. We believe that because of the high cost of this antenna system for the recreational HF user, the alternative mono-band approach needs to be considered.

In other words, we would love everyone to buy an SG-303 but we understand that they are not for everyone.

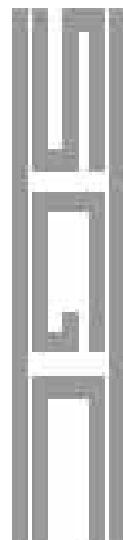

SG-500 SMART POWERCUBE™

The SmartPowerCube is a 500 watt power amplifier.

The SG-500 Smart PowerCube is an intelligent - micro processor controlled - high powered linear amplifier that dramatically boosts your HF power. The intelligent part comes into play because the Smart PowerCube constantly monitors your HF-SSB activities, power needs and antenna conditions and then automatically, in less than 15 milliseconds, selects the right broadband filter. The SG-500 has been designed to operate in an unattended environment, even in hard to reach places where access may be limited. But for precaution, a series of status LED's on the front panel function as built-in test equipment (BITE) so the operator can quickly determine any fault which may have occurred. The SG-500 fits into service in fixed, mobile and marine



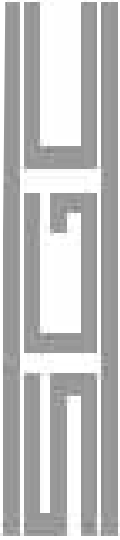

applications. The Smart PowerCube is, in fact, a cube, taking up less than 1 cubic foot of space and weighing in at only 9.5 kg (21 lbs). The unit is built tough, and boasts a cast aluminum enclosure and extra heavy duty heat sinks, powder coat finish and only the most durable electronic components and assembly techniques.

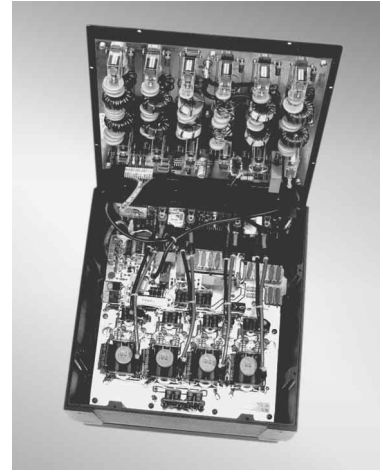

SG-500 SMART POWERCUBE™ BENEFITS & FEATURES

Intelligent power is the selling feature of the SG-500 watt power amplifier. The unit produces enough power to be within half "S" unit (3dB) of a 1kW amplifier. This dramatic shot of power will enhance any SSB transmission. The intelligence of the system is its' ability to automatically adjust the amplifier input sensitivity, selecting the correct filter band, while monitoring all parameters for faults.



A heavy duty cooling fan option is available for continuous CW use. Remember also that the Smart PowerCube requires a coupler and antenna system which meet the same power levels. And, if using the Smart PowerCube with the SG-2000 transceiver, you will need the heavy duty PS-50 power supply.

THE OTHER SGC PRODUCTS

We do a lot of things besides the products which are highlighted here: some of them are very interesting and worth knowing about from a purely awareness standpoint.

PRC-2250 MIL

The PRC-2250-MIL is the ruggedized version of the SG-2000. It is basically the same board structure, but it is supplied in a camouflage color, with a waterproof microphone / handset, military type shock mounting, heavy duty cooling fans, special modifications for key down continuous service in the data modes, a remote head with 16 feet of cable installed, RS-232 computer interface and software and comes with computer codes to allow installation of third party HF adaptive controllers.

SG-715 MANPACK

The SG-715 manpack is a small portable transceiver which covers up to 15 MHz and is available in synthesized versions which can be ordered on a direct entry or channelized configuration. The radio is also available crystal controlled and this is the most commonly supplied.

A lot of domestic US radio persons might be a little surprised at this, but the reason for the choice of crystal control is that the crystal system uses far less power in the standby and receive modes than the synthesizer. So when various countries and groups like the UN come to us and tell us they will be in the field for 2 weeks and longer at a time and they need to maintain critical communications, we outfit them with our manpacks and the manpack solar kit which will keep them on the air indefinitely.

**The SG-715
portable manpack
is a waterproof unit
designed for field
operations.**



This radio is completely submersible and is available in a waterproof (floating) carrying case which is international orange. It is suitable for survival at sea missions and we have dozens of them deployed in survival capsules aboard off shore oil rigs. The next time you plan to be blown off an oil rig in a typhoon, this is the radio we would recommend. Or, you could choose the SG-715 for your next expedition to the North Pole, as did the National Geographic Expedition.

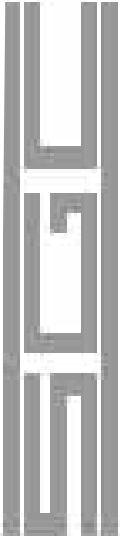

SG-1000-1 LINEAR AMPLIFIER

The SG-1000-1 is a brute of an amplifier. It is not like the hobby class of amplifier. Each one of these is a hand crafted work of art which is more akin to a small short-wave broadcast system than a linear amplifier. To give you an idea of the kind of quality we are talking about, we will tell you that the burn in process is a long one. We put a key down signal through the amplifier into a big dummy load for 2 weeks.

The power supply will put out 28 volts at 80 amps continuously from now until you run out of electricity.

FEATURES/BENEFITS OF SG-2000

- FEATURE** Type Approved Radio
BENEFIT: Great for marine, highly stable and rugged.
BENEFIT: No risk of FCC Fines! - Risks with a modified ham rig at sea: 1) No 2182 alarm, 2) not enough memories, 3) not built for the environment - KA7ZVI \$8,000 fine (QST June 92 page 57-58)
- FEATURE** American Made
BENEFIT: American quality and American design.
- FEATURE** 4 Transistors in LPA
BENEFIT: Conservative ratings = long product life.
- FEATURE** Multiple Heads
BENEFIT: Control from anywhere
BENEFIT: Appearance/flexibility
- FEATURE** Complete telephone control
BENEFIT: Install remote control easily using telephone lines

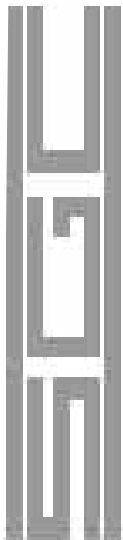

QMS FEATURES AND BENEFITS

FEATURE	No Holes Mounting
	BENEFIT: Won't affect resale value of auto
FEATURE	Full frequency coverage 1.8 to 30 MHz continuous
	BENEFIT: You don't have to get out of vehicle to change bands or resonant frequency
FEATURE	Quick Removal
	BENEFIT: Easily transferable from one vehicle installation to another
FEATURE	Strong Strapping/Suction cups
	BENEFIT: Rugged installation
FEATURE	Foolproof installation
	BENEFIT: Best signal possible

SG-230 FEATURES AND BENEFITS

FEATURE	Matches anything
BENEFIT:	Flexibility of antennas
FEATURE	Hands free tuning
BENEFIT:	Ease of operation
FEATURE	Wide Frequency coverage
BENEFIT:	One antenna 1.8 to 30 MHz
FEATURE	Wide impedance range
BENEFIT:	Wide choice of antennas
FEATURE	Waterproof
BENEFIT:	Great for marine systems





SG-303 FEATURES & BENEFITS

FEATURE	Rugged construction
BENEFIT:	Won't break - 70 mph rated - 100% Replacement Guarantee for 5 years
FEATURE	Wide frequency coverage
BENEFIT:	No traps, wires or guesses
FEATURE	Dual element
BENEFIT:	Maximum performance all frequencies
FEATURE	Big elements
BENEFIT:	Lowest loss all frequency antenna made
FEATURE	Matches SG-230
BENEFIT:	Tunes without intervention

CHAPTER 8

**GLOSSARY AND
GENERAL ELECTRONIC
AND HF SSB
ABBREVIATIONS**

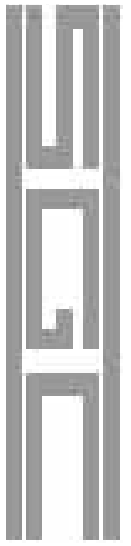

GLOSSARY AND GENERAL ELECTRONIC AND HF SSB ABBREVIATIONS

- (+)positive (power supply input)
- (-)negative (power supply input)
- A3Amode of single sideband with -16dB pilot carrier
- A3HAME or AM compatible (carrier with only upper sideband)
- A3J.....telephony; single sideband with suppressed carrier
- AGC.....automatic gain control which prevents receiver overload
- ALC.....automatic loading control which prevents transmitter overload
- AMPamplifier
- AMTOR.....amateur radio equivalent of SITOR with slightly different standards
- ATTN.....attenuator which reduces a received signal
- ADSP™Adaptive Digital Signal Processing; exclusive to SGC, a DSP technology which processes the signal to eliminate unwanted noise and improve incoming signal
- AMamplitude modulation, low efficiency type of radio transmission generally used for broadcast AM radio station bands with 100% carrier inserted
- AMVER.....Coast Guard operated system for rescue "automated mutual assistance vessel rescue system"
- ANTENNA.....any part of any SSB system that radiates radio energy
- ARQ.....automatic repeat request; a mode to compare transmission; a repeat signal is sent only when requested by the receiving station
- BAND.....a range of frequencies, usually within a one MHz span
- BANK.....a collection of channels to be scanned as a group in order
- CHAN.....channel
- CHASSIS GNDchassis or cabinet ground
- CLARclarifier; allows receiver frequency to be offset slightly from transmitter frequency
- COMMcommunication; also used to reference serial communications computer port
- CW.....continuous wave; to transmit the mode of Morse code
- CRYSTALa piece of quartz mineral that will resonate at a particular frequency and used as a reference in transceivers
- COAX.....an electrical conductor which carries radio energy from a transmitter to an antenna system; the inner conductor is insulated from an external wire mesh shield
- DATA I/Odata input/output
- DCdirect current

DUPLEXa method of frequency in which ship stations transmit on one frequency while shore stations transmit a different frequency

DSP.....digital signal processing; technology which eliminates unwanted noise to enhances a signal

EMERemergency

FEC.....forward error correction; a mode to compare transmission; each character is sent twice and the redundancy of the code serves as the check

FEEDLINE.....the method of connecting the antenna to the radio

FREQUENCYthe number of polarity alternations per second measured in Hertz.
KHz = thousand Hertz; MHz = million Hertz

FMfrequency modulation

FWDforward transmit power going to the antenna

GAINthe amount of amplification a system has; in antenna systems, the gain is the measurement of the directional characteristics

GROUND.....a connection to earth or an earth counterpoise

GROUNDPLANE.....an artificial ground used for antenna systems

GROUNDWAVE.....a radio signal that travels along the earth, bending over the horizon

GMTGreenwich Mean Time (universal time) the international standard time referred to the zero degree meridian

HF.....(High Frequency), a band of frequencies above 2 MHz used for long range communications; also the shortwave frequencies

IMPEDANCE.....the apparent opposition in an electrical circuit to the flow of an alternating current

IONOSPHERE.....electricity conducting layers in the earth's upper atmosphere

LCDliquid crystal display

LPA.....linear power amplifier

LSB.....lower sideband

MEMORYa computer memory address to which channel information may be assigned

MHZ.....megahertz

MF(Medium Frequency), a band of frequencies in the 2 MHz range used for short range communications

MODULATIONthe process of varying the amplitude, frequency or phase of a carrier or signal

OSCILLATOR.....a device that produces alternating current

PCBprinted circuit board

PTT.....push to talk

PEPpeak envelope power; commonly a power output rating



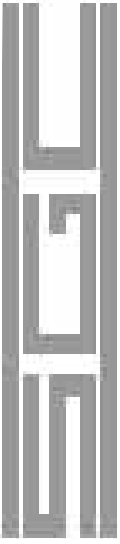

PROPAGATION.....	the characteristics of different radio frequency transmissions, generally in regard to usable distance in relation to frequency and time of day
RF	radio frequency; any frequency higher than a person can hear
RESONATE.....	the frequency that a circuit is tuned to
RADIATE.....	the movement of energy away from a place, as in the radiation of an antenna
SSB	Single Side Band; a high efficiency type of radio transmission generally used for long distance communications where energy is not radiated until modulation is present
SQL	squelch
SIMPLEX.....	a method of frequency use in which stations transmit and receive on the same frequency
SITOR.....	a commercial system of radio teletype for ship to shore, ship to ship and between ships and any telex subscriber; "ship international transmitting over radio"
SKIP	the bounce of the radio signal off the ionosphere
SKYWAVE	a radio signal which is projected into the ionosphere and bounces one or more times before returning to earth
SYNTHESIZER	the device that produces and controls frequencies through synthetic means
SNS™.....	exclusive to SGC; spectral noise subtraction; works with DSP in signal processing to improve incoming signals
TELEX	a commercial service involving teletypewriters connected through automatic exchange; "teleprinter + exchange"
TRANSCEIVER	a term applied to equipment that both transmits and receives
USB	upper sideband
UTC.....	coordinated universal time; same as GMT
VCO.....	voltage controlled oscillator
VHF	Very High Frequency; commonly refers to a short range type of radio whose signal is transmitted on a line of sight from antenna to antenna
VSWR	voltage standing wave ratio; a measurement of the efficiency of an antenna system; it measures the energy which is projected out and reflected back to the antenna
VOLTAGE.....	a measurement of electrical pressure of the current times resistance
VDC.....	voltage direct current
WAVELENGTH.....	distance between two successive radio waves
WORK.....	to be in radio contact or communication with another station
XMT	transmit
XFMR.....	transformer

SGC IDEAS AND OPPORTUNITIES

SGC is an equal opportunity employer. We are a progressive engineering, manufacturing and sales company with employment opportunities in the following fields. If you have an interest in joining a team of communications specialists, please call or fax our corporate offices with your summary experience and qualifications.

Officers and Administration

Management

Electronic Production

RF Engineering

Technicians

Technical Writers

Marketing and Sales

In addition, SGC is always searching for innovative ideas to further the market of HF communications. Please forward your comments and ideas in any of the following areas:

DSP (Digital Signal Processing)

Data Communications

Analog RF

Receivers

Transmitters

Antennas

Antenna Couplers

SGC QUOTATION REQUEST

SGC makes the world's finest HF SSB radios covering marine, commercial, MARS, CAP, military and amateur applications. A wide range of accessories are available. When you need HF communications, please call or fax SGC for a quotation. Our toll free telephone number in the USA is: 1-800-259-7331. Outside the USA, call (425) 746-6310 or use the convenient fax form below.

Your Name: Telephone:

Company: Fax Number:

1. Primary use: Marine: Amateur: Commercial: Aircraft: Mobile:

2. Is a remote head desired? Yes No

3. Do you need additional control heads? Yes No If "Yes", number.....:

4. Do you need an A.C. power supply? Yes No

5. Do you need an antenna? Yes No

If "Yes", type desired: Long wire: Dipole: 8 ft. Whip: 28 ft. Whip:

6. How many units do you need?

7. How soon do you need delivery?days

8. Do you need a SITOR modem? Yes No

9. Do you have special requirements? Yes No

Specify:

.....

.....

.....

Fax this form to SGC (425) 746-6384

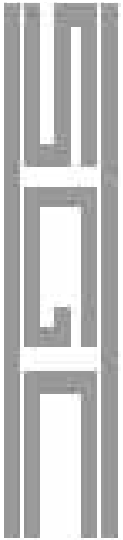



“ No Compromise Communications ”



The SGC Building
13737 S.E. 26th Street, Bellevue, Washington 98005, USA
Telephone (206) 746-6310 • Fax (206) 746-6384

1-800-259-7331